



SCHWERT
DENTAL **19**
SEIT 1896



Chirurgie

Surgery

51

Chirurgie
Surgery



2. Chirurgie · Surgery

SAFE-EX Sicherheitsklingenhalter · SAFE-EX Safety blade holder

SAFE-EX



i

SAFE-EX · SAFE-EX

Das alltägliche Verletzungsrisiko beim Aufnehmen und vor allem dem Entfernen der Klinge vom Skalpell Griff ist mit herkömmlichen Instrumenten unvermeidlich. Mit dem neuen SCHWERT SAFE-EX hat man eine Innovation geschaffen die den Praxisalltag verändert. Die im Griff integrierte Funktion, ähnlich der Benutzung eines Kugelschreibers, reduziert die Verletzungsgefahr auf ein Minimum. Die Klinge wird beim SAFE-EX per Knopfdruck am distalen Ende einfach ausgeworfen. Praxispersonal wird im Zuge der Wiederaufbereitung wirksam vor Krankheitsübertragungen und Infektionen durch Schnitte geschützt.

The daily risk of injuries by mounting and especially dismantling of blades is not avoidable by standard blade holders. With the new SCHWERT SAFE-EX an innovation was developed that changes the daily routine eminently. The integrated function that works like a regular ball pen reduces the risk of an injury to a minimum. The blade is ejected from the SAFE-EX just by pushing the button on the distal end. The practice staff, especially during the re-processing, is safe from infections caused by unintended cuts.

52









1033-60

Sicherheitsklingenhalter,
ergonomische Form,
zerlegbar
Safety blade holder,
ergonomic shape,
dismountable

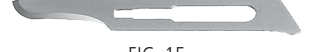

2. Chirurgie · Surgery

Skalpellklingen / Skalpellgriffe · Scalpel blades / Scalpel handles

	100 Stk., unsteril 100 pcs., non-sterile	100 Stk., steril 100 pcs., sterile
 FIG. 10	1053-110	1063-10*
 FIG. 11	1053-111	1063-11*
 FIG. 12	1053-112	1063-12*
 FIG. 12D	1053-112D	1063-12D*
 FIG. 15	1053-115	1063-15*
 FIG. 15C	1053-115C	1063-15C*



1033-50

Edelstahl,
ergonomische Form
Stainless steel,
ergonomic shape



1043-1



1043

FIG. 3



SCHWERT
SWORD · ESPADA
EPEE · SPADA

53

Chirurgie
Surgery



2. Chirurgie · Surgery

Skalpellgriffe · Scalpel handles



3405
BLAKE



1033-1



1033-10

1,0 mm, zum
Präparieren von
feinen und präzisen
Gewebestreifen
1.0 mm, for dissec-
tion of precise and
delicate soft tissue
grafts

1033-15

1,5 mm, zum
Präparieren von
feinen und präzisen
Gewebestreifen
1.5 mm, for dissec-
tion of precise and
delicate soft tissue
grafts



1033-3

2. Chirurgie · Surgery

Skalpelligriffe / Klingentferner · Scalpel handles / Blade remover



SCHWERT
SWORD · ESPADA
EPEE · SPADA

55

Chirurgie
Surgery



1035
Rasierklingelhalter
Razor blade holder

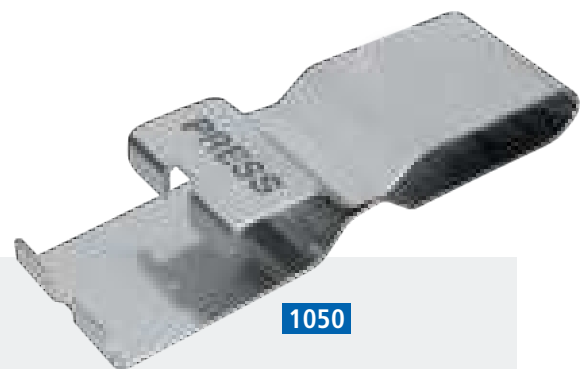

1050

Klingentferner · Blade remover

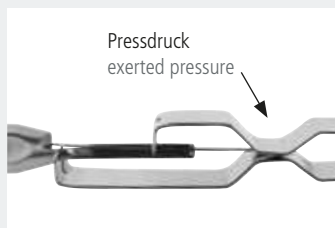



2. Chirurgie · Surgery

ULTRA Scheren · ULTRA Scissors

ULTRA^{SCHEREN}_{SCISSORS}



ULTRA^{SCHEREN}_{SCISSORS}

SCHWERT
SWORD · ESPADA
EPEE · SPADA

56

i

ULTRA Scheren · ULTRA scissors

In der Praxis sind perfekt funktionierende Instrumente gefordert um Zeit zu sparen und noch präzisere Eingriffe zu ermöglichen. Die neuen schwarz beschichteten SCHWERT ULTRA Scheren vereinigen dabei die Vorteile bekannter SuperCut Scheren mit einer extrem harten und widerstandsfähigen Oberfläche:

- Extrem harte und glatte Oberfläche für präzisen Gang und geringen Verschleiß
- SuperCut Schliff für rasiermesserscharfes Schneiden und weniger Trauma. Ein Scherblatt mikroverzahnt damit Faden oder Weichgewebe nicht abrutschen
- Die blendarme schwarze Beschichtung verbessert die Sicht und bietet hervorragenden Kontrast im ausgeleuchteten Mundraum für noch präzisere Eingriffe
- Besonders beständig gegen Chemikalien in der Wiederaufbereitung
- Als „La Grange“ Figur erhältlich › Anatomische S-Form für guten Zugang in allen Quadranten

In today's practice perfectly functioning instruments are required to save time and still allow more precise treatments. The new black coated SCHWERT ULTRA Scissors combine the advantages of known SuperCut with an extremely hard and durable surface:

- Extremely hard and smooth coating for a precise feeling and less wear
- SuperCut finish for razor sharp cutting and less trauma. One blade micro serrated so that thread or soft tissue will not slip off
- The low-glare black coating improves visibility and provides excellent contrast to the gingiva. For even more precise surgical interventions
- Highly resistant to chemicals and thus excellently clean and sterilizable
- Available as "La Grange" figure › Anatomical S-shape for easy access in all mouth areas



SCHWERT
SWORD · ESPADA
EPEE · SPADA

57

Chirurgie
Surgery



i

SCHWERT Scheren · SCHWERT scissors

SCHWERT Premium Scheren

- speziell gehärteter Stahl
- Präzise Schnittführung über die gesamte Blattlänge
- leichter Gang

SC Scheren (SuperCut)

- spezieller, extrem scharfer Schnittwinkel für verringertes Trauma und weniger Kraftaufwand
- eine Schneide Mikroverzahnt um Abrutschen von Faden und Weichgewebe zu verhindern
- Goldmarkierung an einem Griff

TC Scheren

- sehr lange Lebensdauer durch Hartmetalleinsätze auf beiden Schneiden, speziell bei hartem Nahtmaterial
- Goldmarkierung an beiden Griffen

SCHWERT Premium scissors

- special steel and hardening
- precise cutting from the tip along the whole blade
- smooth cutting

SC scissors (SuperCut)

- very sharp – less effort and trauma due to a special cutting edge
- one blade micro serrated to avoid suture and tissue slippage
- one handle gold coated

TC scissors

- long durability due to Tungsten carbide inserts on both blades, especially for hard sutures
- both handles gold coated

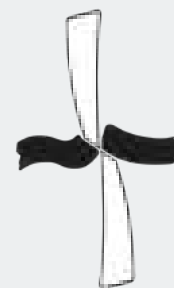

Normale Scheren
Ordinary scissors

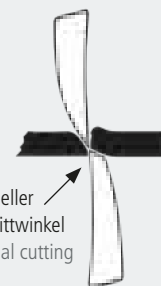

spezieller Schnittwinkel
special cutting edge

SC Scheren
SC scissors



2. Chirurgie · Surgery

Scheren · Scissors



58



1110

IRIS
11,5 cm
gerade
straight



1110-400

IRIS **SC**
11,5 cm
gerade
straight



1111

IRIS
11,5 cm
gebogen
curved

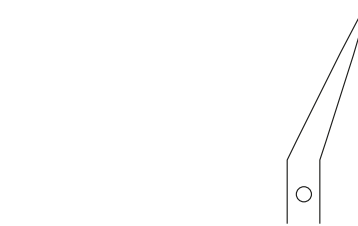

1113

IRIS
11,5 cm
kniegebogen
bent

1180

IRIS **TC**
11,5 cm
gerade
straight

1110-400B

IRIS **ULTRA**
11,5 cm
gerade
straight

1181

IRIS **TC**
11,5 cm
gebogen
curved

1111-400B

IRIS **ULTRA**
11,5 cm
gebogen
curved





i

LA GRANGE Schere · LA GRANGE scissors

- der Mund Anatomie angepasste S-Form
- kein Abrutschen von Nahtmaterial oder Weichgewebe
- ideal auch für den Molarenbereich
- S-shape, perfectly suitable for all mouth areas
- serrated blade grabs to prevent tissue or suture slipping
- especially for the molar region



1133
LA GRANGE
11,5 cm
S-Form
S-shape

1133-400
LA GRANGE **SC**
11,5 cm
S-Form
S-shape

1133-200
LA GRANGE **TC**
11,5 cm
S-Form
S-shape

1133-400B
LA GRANGE **ULTRA**
11,5 cm
S-Form
S-shape

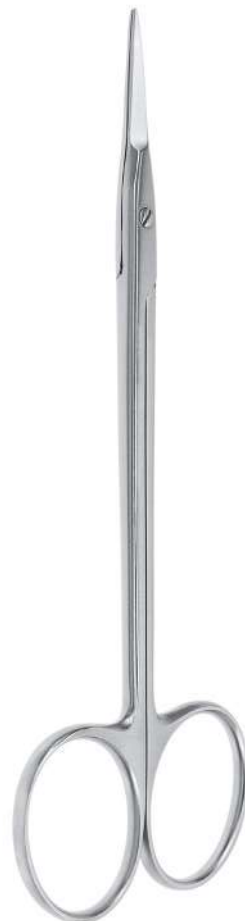

1114
TURMSPITZ
11,5 cm
gerade
straight



1115
TURMSPITZ
11,5 cm
gebogen
curved



1114-1
TURMSPITZ
12,0 cm
gerade
straight

sehr fein
very fine



1115-1
TURMSPITZ
12,0 cm
gebogen
curved

sehr fein
very fine



2. Chirurgie · Surgery

Scheren · Scissors

SCHWERT
SWORD · ESPADA
EPEE · SPADA

60

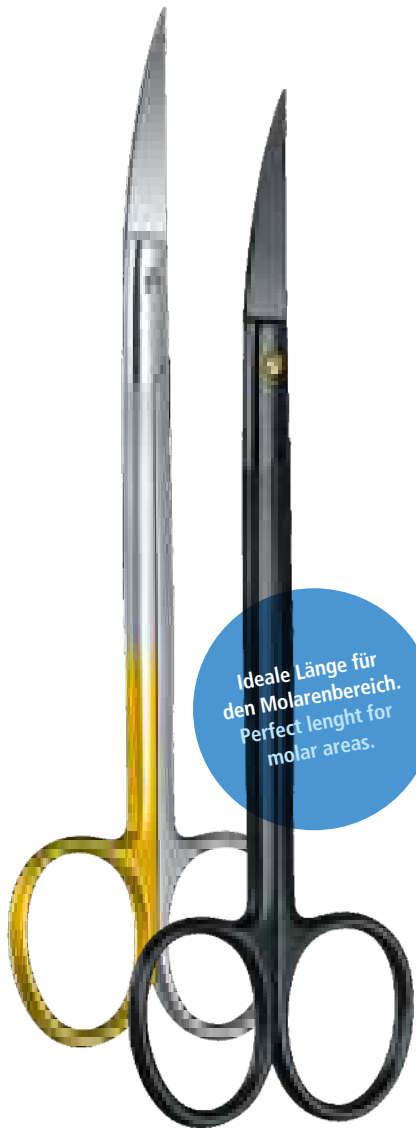

Ideale Länge für
den Molarenbereich.
Perfect length for
molar areas.



1124
JOSEPH
14,0 cm
gerade
straight



1125
JOSEPH
14,0 cm
gebogen
curved

1125-400

JOSEPH **SC**
14,0 cm
gebogen
curved

1125-400B

JOSEPH **ULTRA**
14,0 cm
gebogen
curved



1120
WAGNER
12,0 cm
gerade
straight



1131
QUINBY
12,5 cm
gebogen
curved





SCHWERT
SWORD · ESPADA
EPEE · SPADA

61

Chirurgie
Surgery



1116

GOLDMANN-FOX
13,0 cm
mikroverzahnt, gerade
micro serrated, straight

1116-400

GOLDMANN-FOX **SC**
13,0 cm
mikroverzahnt, gerade
micro serrated, straight

1116-200

GOLDMANN-FOX **TC**
13,0 cm
mikroverzahnt, gerade
micro serrated, straight



1117-1

GOLDMANN-FOX
13,0 cm
mikroverzahnt, S-Form
micro serrated, S-shape



1117

GOLDMANN-FOX
13,0 cm
mikroverzahnt, gebogen
micro serrated, curved

1117-400

GOLDMANN-FOX **SC**
13,0 cm
mikroverzahnt, gebogen
micro serrated, curved

1185

GOLDMANN-FOX **TC**
13,0 cm
mikroverzahnt, gebogen
micro serrated, curved

1117-400B

GOLDMANN-FOX **ULTRA**
13,0 cm
gebogen
curved





2. Chirurgie · Surgery

Scheren · Scissors



1152
LOCKLIN
16,0 cm

1152-1
LOCKLIN
16,0 cm
mikroverzahnt
micro serrated



1142
KELLY
16,0 cm
gerade
straight

1143
KELLY
16,0 cm
gebogen
curved

1143-400
KELLY **SC**
16,0 cm
gebogen
curved

1187
KELLY **TC**
16,0 cm
gebogen
curved



1147-1
DEAN
17,5 cm
gezahnt, S-Form
saw edge, S-shape

1147-400
DEAN **SC**
17,5 cm
S-Form
S-shape

1147-51
DEAN **TC**
17,5 cm
S-Form
S-shape



SCHWERT
SWORD · ESPADA
EPEE · SPADA



1168

SPENCER
9,0 cm
Ligatureschere
Ligature scissors
gerade
straight

1168-11

SPENCER
11,0 cm
Ligatureschere
Ligature scissors
gerade
straight

1168-200

SPENCER
11,0 cm
Ligatureschere
Ligature scissors
kniegebogen
bent



1162-13

Chirurgische
Schere
13,0 cm
gerade
straight



1163-13

Chirurgische
Schere
13,0 cm
gebogen
curved

2. Chirurgie · Surgery

Scheren · Scissors

i

Metzenbaum Präparierschere Metzenbaum preparation scissors

Die Präparierschere nach Metzenbaum ist lediglich in zweiter Instanz zum Schneiden entworfen. Diese Scherenvariante dient zur Präparation und atraumatischen Trennung der von Gewebsschichten innerhalb des gesamten Weichgewebereichs. Präparierscheren zeichnen sich durch ihre verrundeten Außenkanten der Schneidblätter und stumpfen Spitzen aus, wodurch sich das Weichgewebe präzise und atraumatisch trennen lässt.

Metzenbaum preparation scissors are only used for cutting in a second instance. These scissors variants are for preparation and atraumatic dissection of tissue layers within the complete soft tissue area. Preparation scissors' blades have rounded outer edges and blunt tips, this combination allows precise and atraumatic dissections.

64



1139-14

METZENBAUM
14,0 cm
gebogen
curved

1139-214

METZENBAUM **TC**
14,0 cm
gebogen
curved

1139-400B

METZENBAUM
ULTRA
14,0 cm
gebogen
curved

1139-18

METZENBAUM
18,0 cm
gebogen
curved



1139-11

METZENBAUM
STRABISMUS
11,5 cm. 4 1/2"
gebogen
curved

sehr fein
very fine



2. Chirurgie · Surgery

Linkshänderscheren · Left-handed scissors



SCHWERT
SWORD · ESPADA
EPEE · SPADA

65

Chirurgie
Surgery

1139-11L

METZENBAUM
10,5 cm
Präparierschere, gerade
undermining /
dissecting scissors, straight



1111-400L

IRIS 
11,5 cm
gebogen
curved

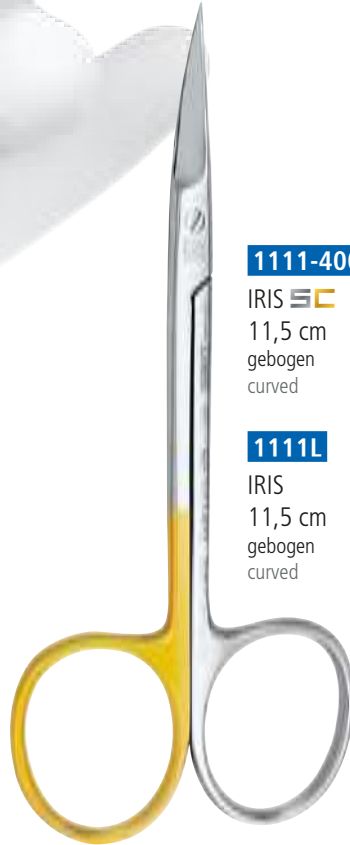

1111L

IRIS
11,5 cm
gebogen
curved

1110L

IRIS
11,5 cm
gerade
straight



i

Linkshänderscheren · Left-handed scissors

Die meisten der 10-20 Prozent Linkshänder in der Bevölkerung kennen das Problem mit Standardscheren, die für Rechtshänder entworfen sind. Scheren werden täglich sehr oft in der Praxis für die verschiedensten Anwendungen benötigt.

Für Linkshänder ist bei „normalen“ Scheren vor allem die Schnittkante schlecht zu sehen. Eine präzise Schnittführung ist damit nur sehr erschwert, oder überhaupt nicht möglich.

Hier bieten die speziellen Scheren von SCHWERT eine deutliche Erleichterung im Praxisalltag.

Most of the 10-20 percent part of left handed know about their problems with standard surgical scissors. Scissors are used very often during the day in your practice.

For left handed it is quite difficult to see the cutting edge of "regular" scissors. Therefore a precise cut is almost impossible.

The new left handed SCHWERT scissors will improve your daily work a lot.



2. Chirurgie · Surgery

Hohlmeißelzangen · Rongeurs

SCHWERT
SWORD · ESPADA
EPEE · SPADA

66



432

LUER-FRIEDMANN
3,0 mm, 30°, 14,0 cm



433

LUER-FRIEDMANN
3,5 mm, 30°, 16,0 cm



436-1

LUER-FRIEDMANN
4,0 mm, 30°, 16,5 cm



sehr grazil
very fine

431-10

MICRO-FRIEDMANN
1,5 mm, 30°, 14,0 cm



431-20

MICRO-FRIEDMANN
1,6 mm, 30°, 15,0 cm



La Grange
Biegung für
universellen
Zugang
La Grange
shape for
universal
approach

431-21

MICRO-FRIEDMANN
1,6 mm, 15,0 cm

2. Chirurgie · Surgery

Hohlmeißelzangen · Rongeurs



SCHWERT
SWORD · ESPADA
EPEE · SPADA

67

Chirurgie
Surgery



434-2
MINI-FRIEDMANN
2,0 mm, 30°, 13,5 cm



434-1
MINI-FRIEDMANN
2,5 mm, 30°, 13,5 cm

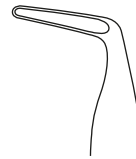

434-0
MINI-FRIEDMANN
2,0 mm, 90°, 13,5 cm

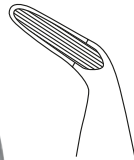

451
BLUMENTHAL
3,5 mm, 45°, 15,0 cm

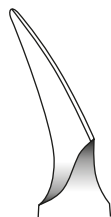

514
CLEVELAND
FIG. 5, 16,0 cm
Knochensplitterzange
Bone cutting forceps



503
BEYER
3,0 mm, 18,0 cm
DOUBLE ACTION

Bessere Kraftübertragung
durch doppelte Übersetzung.
More power due to double
transmission.



2. Chirurgie · Surgery

Pinzetten anatomisch / atraumatisch · Dressing forceps / Atraumatic forceps

i

DE BAKEY Pinzette · DE BAKEY forceps

Die DE BAKEY ist eine atraumatische Pinzette, die vor allem zum Fassen und Halten von empfindlichen Gefäßen und Weichgewebe geeignet ist. Durch ihre spezielle Zahnung wird der Druck auf das Gewebe auf eine viel größere Oberfläche verteilt und das Trauma deutlich reduziert.

The DE BAKEY is an atraumatical tissue forceps, suitable especially for holding sensitive vessels and soft tissue. Due to its special serration, the pressure is distributed over a larger surface and reduces the trauma significantly.

68



1225-15TC

DE BAKEY **TC**
1,5 mm
15,0 cm

atraumatisch mit
TC-Einlagen
Länge 15 cm
Breite 1,5 cm
TC-Länge 6 mm
Riefung Länge 4 mm
atraumatic with
TC inserts
length 15 cm
width 1,5 mm
TC lenght 6 mm
serration lenght 4 mm



1225-15

DE BAKEY
1,5 mm
15,0 cm

1223-15

DE BAKEY
2,0 mm
15,0 cm



1224-15

DE BAKEY
2,0 mm
15,0 cm

1207

ADSON
1,0 mm
12,0 cm

1220-12

ADSON **TC**
1,7 mm
12,0 cm

1220-15

ADSON **TC**
1,7 mm
15,0 cm

1207-115

MICRO-ADSON
0,8 mm
15,0 cm

sehr fein
very fine



2. Chirurgie · Surgery

Pinzetten anatomisch · Dressing forceps



SCHWERT
SWORD · ESPADA
EPEE · SPADA

69

Chirurgie
Surgery



1197-13

SEMKEN
1,2 mm
13,0 cm

1197-15

SEMKEN
1,5 mm
15,0 cm

1210

TAYLOR
1,5 mm
17,5 cm



1201-14

2,0 mm
14,0 cm



1213

CUSHING
1,2 mm
18,0 cm



1205-13

3,0 mm
13,0 cm

1205-14

3,4 mm
14,0 cm

2. Chirurgie · Surgery

Pinzetten chirurgisch · Dissecting forceps



SCHWERT
SWORD · ESPADA
EPEE · SPADA

70



1208

ADSON
1x2, 1,5 mm
12,0 cm



1218

GILLES
1x2, 1,6 mm
16,0 cm



1208-115

MICRO-ADSON
1x2, 1,0 mm
15,0 cm

sehr fein
very fine



1208-215

MICRO-ADSON
1x2, 1,0 mm
15,0 cm
gebogen
curved

sehr fein
very fine



1198-13

SEMKEN
1x2, 1,5 mm
13,0 cm

1198-15

SEMKEN
1x2, 1,6 mm
15,0 cm

1198-131

SEMKEN
1x2, 1,5 mm
13,0 cm

2. Chirurgie · Surgery

Pinzetten chirurgisch / Nahtpinzette · Dissecting forceps / Suture forceps



SCHWERT
SWORD · ESPADA
EPEE · SPADA

71

Chirurgie
Surgery



1202-14

1x2, 1,7 mm
14,0 cm



1212

TAYLOR
1x2, 1,5 mm
17,5 cm



1206-14

1x2, 2,3 mm
14,0 cm



1214-1

MICRO-CUSHING
1x2, 0,9 mm
17,5 cm

sehr fein
very fine



2110

Nahtpinzette
Suture forceps
15,0 cm

2. Chirurgie · Surgery

Arterienklemmen · Haemostatic forceps



1254
HALSTED-
MOSQUITO
12,5 cm



1254-14
HALSTED-
MOSQUITO
14,0 cm



1255
HALSTED-
MOSQUITO
12,5 cm



1255-14
HALSTED-
MOSQUITO
14,0 cm



1256
HALSTED-
MOSQUITO
1 x 2 Zähne
1 x 2 teeth
12,5 cm



1257
HALSTED-
MOSQUITO
1 x 2 Zähne
1 x 2 teeth
12,5 cm

72



1248
KELLY
14,0 cm



1249
KELLY
14,0 cm



1260
MICRO-
HALSTED
9,5 cm



1261
MICRO-
HALSTED
9,5 cm

2. Chirurgie · Surgery

Tuchklemme / Kornzange · Towel clip / Dressing forceps



SCHWERT
SWORD · ESPADA
EPEE · SPADA

73

Chirurgie
Surgery



1284-9

BACKHAUS
9,0 cm
Tuchklemme
Towel clip

1284-11

BACKHAUS
11,0 cm
Tuchklemme
Towel clip



1280

JONES
9,0 cm
Tuchklemme
Towel clip

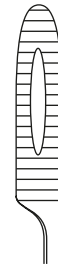

1290-20

GROSS
20,0 cm
Kornzange
Dressing forceps

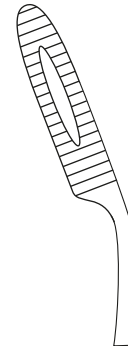

1291-20

GROSS
20,0 cm
Kornzange
Dressing forceps



2. Chirurgie · Surgery

Scharfe Löffel · Bone curettes



1371-1 LUCAS FIG. 85, Ø 2,5 mm
LUCAS FIG. 85, Ø 2,5 mm



1371-2 LUCAS FIG. 86, Ø 3,0 mm
LUCAS FIG. 86, Ø 3,0 mm

74



1361-0 HEMINGWAY Ø 2,0 mm
HEMINGWAY Ø 2.0 mm



1361-1 HEMINGWAY Ø 2,5 mm
HEMINGWAY Ø 2.5 mm



1361-2 HEMINGWAY Ø 3,0 mm
HEMINGWAY Ø 3.0 mm



1361-3 HEMINGWAY Ø 3,5 mm
HEMINGWAY Ø 3.5 mm



1375-1 LUCAS FIG. 85, Ø 2,5 mm
LUCAS FIG. 85, Ø 2.5 mm



1375-2 LUCAS FIG. 86, Ø 3,0 mm
LUCAS FIG. 86, Ø 3.0 mm



i

SCHWERT Design · LUCAS Küretten · LUCAS curettes

Die bewährten Lucas Küretten im SCHWERT Design Griff für ein optimales Handling. Die Größen 1,5 mm, 2,5 mm und 3,0 mm sind nun neben der Standardausführung auch mit gezahnten Arbeitsenden verfügbar. Die feine Zahnung ermöglicht dabei eine ideale Behandlung, im Bereich der Zystenentfernung und wirkt effektiv einem Wegrutschen, an der zu behandelnden Stelle entgegen.

The proven Lucas curettes in the SCHWERT design handle for a precise handling. The sizes 1.5 mm, 2.5 mm and 3.0 mm are now beside the standard figures also available with serrated working tips. The fine serration allows an ideal treatment in the area of removing cysts and avoids effectively a slipping away from the spot which has to be treated.



1372-0 LUCAS Kürette, Ø 1,5 mm, ungezahnt
LUCAS curette, Ø 1.5 mm, non-serrated



1372-1 LUCAS Kürette, Ø 2,5 mm, ungezahnt
LUCAS curette, Ø 2.5 mm, non-serrated



1372-2 LUCAS Kürette, Ø 3,0 mm, ungezahnt
LUCAS curette, Ø 3.0 mm, non-serrated



1372-10 LUCAS Kürette, Ø 1,5 mm, gezahnt
LUCAS curette, Ø 1.5 mm, serrated



1372-11 LUCAS Kürette, Ø 2,5 mm, gezahnt
LUCAS curette, Ø 2.5 mm, serrated



1372-12 LUCAS Kürette, Ø 3,0 mm, gezahnt
LUCAS curette, Ø 3.0 mm, serrated

Chirurgie
Surgery



2. Chirurgie · Surgery

Raspatorien · Periosteals

SCHWERT
SWORD · ESPADA
EPEE · SPADA

76

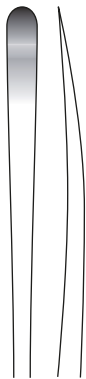

1415
WILLIGER
4,5 mm
12,5 cm

1416
WILLIGER
6,0 mm
16,0 cm



1413-1
OBWEGESER
6,0 mm
17,5 cm



1413-2
OBWEGESER
7,0 mm
17,5 cm



1413-3
OBWEGESER
9,0 mm
17,5 cm



1413-4
OBWEGESER
11,0 mm
17,5 cm



1705-4
Mucoperiosteal
elevator
Micro flap
elevator
2,8 / 3,5 mm



1408
FREER
4,0 / 4,0 mm
stumpf / scharf
blunt / sharp

2. Chirurgie · Surgery

Raspatorien · Periosteals



SCHWERT
SWORD · ESPADA
EPEE · SPADA

77

Chirurgie
Surgery



1407-24

MOLT
FIG. 2/4
3,0 / 6,0 mm

1400

MOLT
FIG. 9
5,0 / 8,0 mm

1406

FOX
5,0 / 7,0 mm

1407

MOLT
5,0 / 5,0 mm

1393

SELDIN
FIG. 23

1393-1

SELDIN
FIG. 23

1405

PRICHARD
10,0 / 5,0 mm

gezahnt
serrated



2. Chirurgie · Surgery

Knochenfeilen / Meißel · Bone files / Chisels

SCHWERT
SWORD · ESPADA
EPEE · SPADA

78



1471
MILLER-
COLBURN
17,0 cm



1472
MILLER-
COLBURN
17,0 cm



1461
MILLER-
COLBURN
17,0 cm



1462
MILLER-
COLBURN
17,0 cm



1650-1
OCHSENBEIN
16,0 cm



1650-2
OCHSENBEIN
16,0 cm



2. Chirurgie · Surgery

Meißel · Chisels



SCHWERT
SWORD · ESPADA
EPEE · SPADA

79

Chirurgie
Surgery



1650-15
WEDELSTAEDT
FIG. 5/6



1650-30
OCHSENBEIN
FIG. 3



1650-40
OCHSENBEIN
FIG. 4



1650-365
RHODES
BACK ACTION
FIG. 36/37



1651-1
FEDI
FIG. 1



1651-2
FEDI
FIG. 2

2. Chirurgie · Surgery

Hämmer · Mallets



SCHWERT
SWORD · ESPADA
EPEE · SPADA

80



1637

210 g, 18,5 cm
Ø 25,0 mm
Einsätze auswechselbar
interchangeable inserts
sterilisierbar bis 140°C
sterilizable up to 140°C

1637-1

(ohne Abbildung · without illustration)
1 Paar Ersatz Teflon Einsätze für **1637**
1 pair replacement Teflon inserts for **1637**

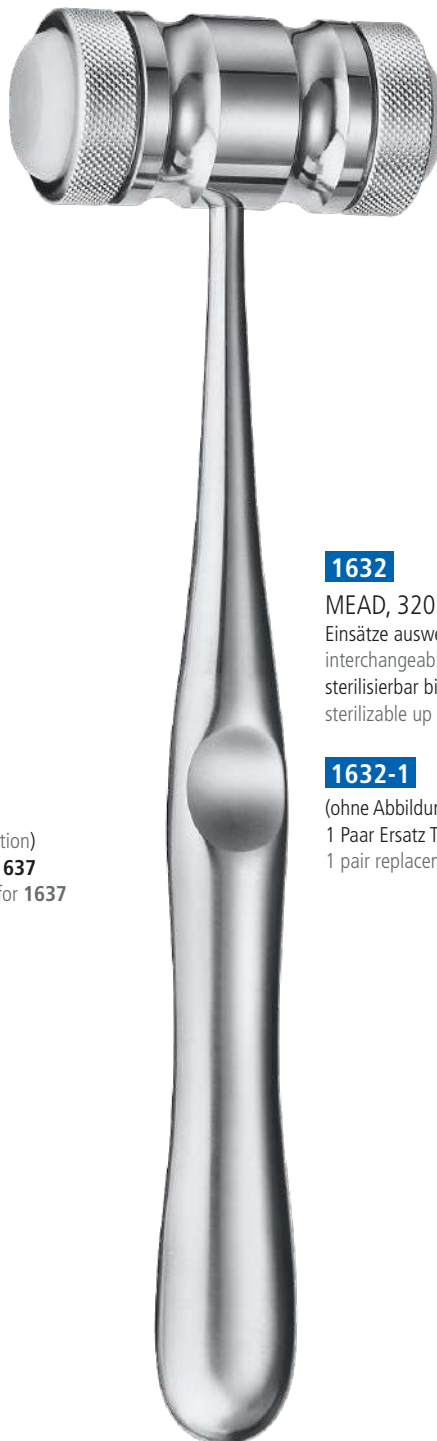

1632

MEAD, 320 g, 19,0 cm
Einsätze auswechselbar
interchangeable inserts
sterilisierbar bis 140°C
sterilizable up to 140°C

1632-1

(ohne Abbildung · without illustration)
1 Paar Ersatz Teflon Einsätze für **1632**
1 pair replacement Teflon inserts for **1632**

Graduierung
graduation
1-20 in mm



1682-4

EPKER
4,0 mm
18,0 cm

1682-6

EPKER
6,0 mm
18,0 cm

1682-8

EPKER
8,0 mm
18,0 cm



1682-16

EPKER
6,0 mm
18,0 cm

1682-18

EPKER
8,0 mm
18,0 cm



1682-26

EPKER
6,0 mm
18,0 cm

1682-28

EPKER
8,0 mm
18,0 cm



1510

LUNIATSCHEK
2,5 mm
Tamponstopfer
Tampon applicator



1510-1

LUNIATSCHEK
1,8 mm
Tamponstopfer
Tampon applicator



1524-13

Ø 1,0 mm
13,0 cm
Kieferhöhlensonde
Antrum probes

1524-14

Ø 2,0 mm
14,0 cm
Kieferhöhlensonde
Antrum probes



SCHWERT
SWORD · ESPADA
EPEE · SPADA

81

Chirurgie
Surgery

2. Chirurgie · Surgery

Abhalter · Retractors

i

SCHAEFER Wundhaken / Wangenhalter SCHAEFER wound / cheek retractor

Kombinierter Wundhaken und Wangenhalter SCHAEFER Doppelt funktionelles Instrument zum Abhalten des Lappens und der Wange bei chirurgischen Eingriffen wie Implantation und Wurzelspitzenresektion.

Combined wound and cheek retractor SCHAEFER Dual-purpose instrument for the retraction of flaps and cheek during surgery such as implantation and apicectomy.



1935
SCHAEFER
23,0 cm



1835
FARABEUF
13,0 cm



1947
BOWDLER-HENRYS
16,5 cm

82

2. Chirurgie · Surgery

Abhalter · Retractors



SCHWERT
SWORD · ESPADA
EPEE · SPADA

83

Chirurgie
Surgery

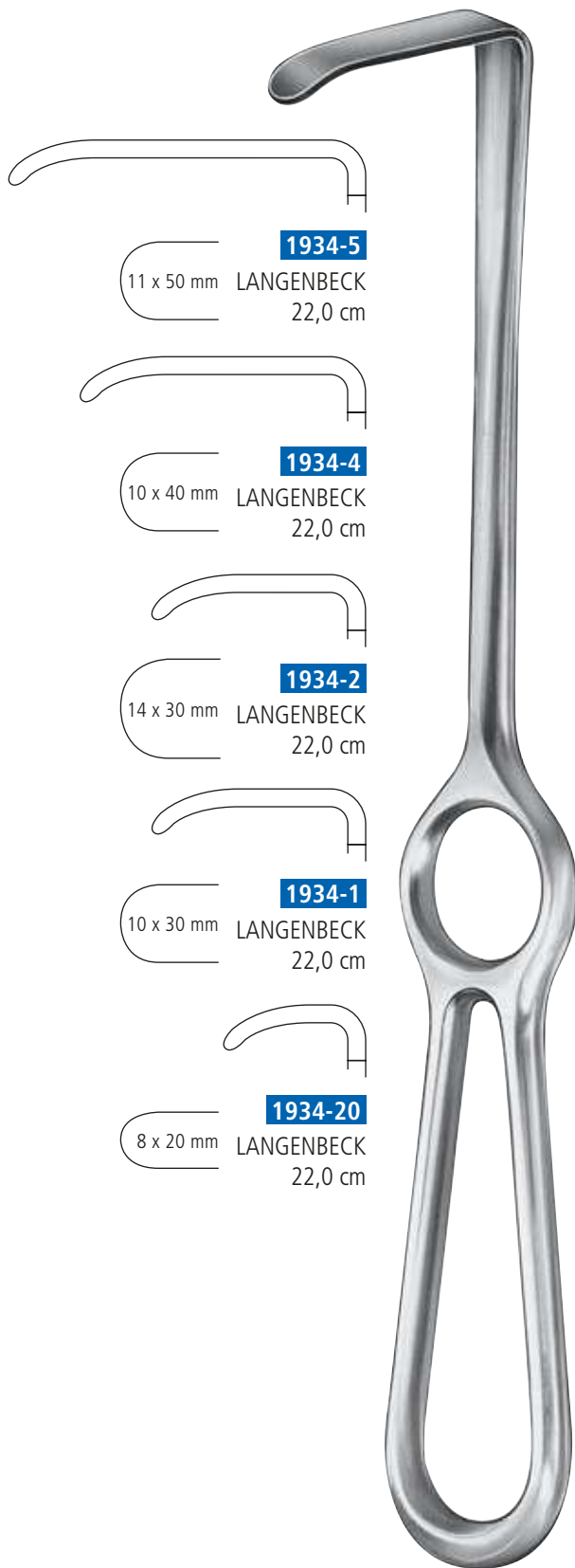

1934-5
11 x 50 mm LANGENBECK
22,0 cm

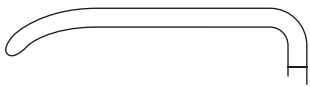

1934-4
10 x 40 mm LANGENBECK
22,0 cm



1934-2
14 x 30 mm LANGENBECK
22,0 cm



1934-1
10 x 30 mm LANGENBECK
22,0 cm



1934-20
8 x 20 mm LANGENBECK
22,0 cm

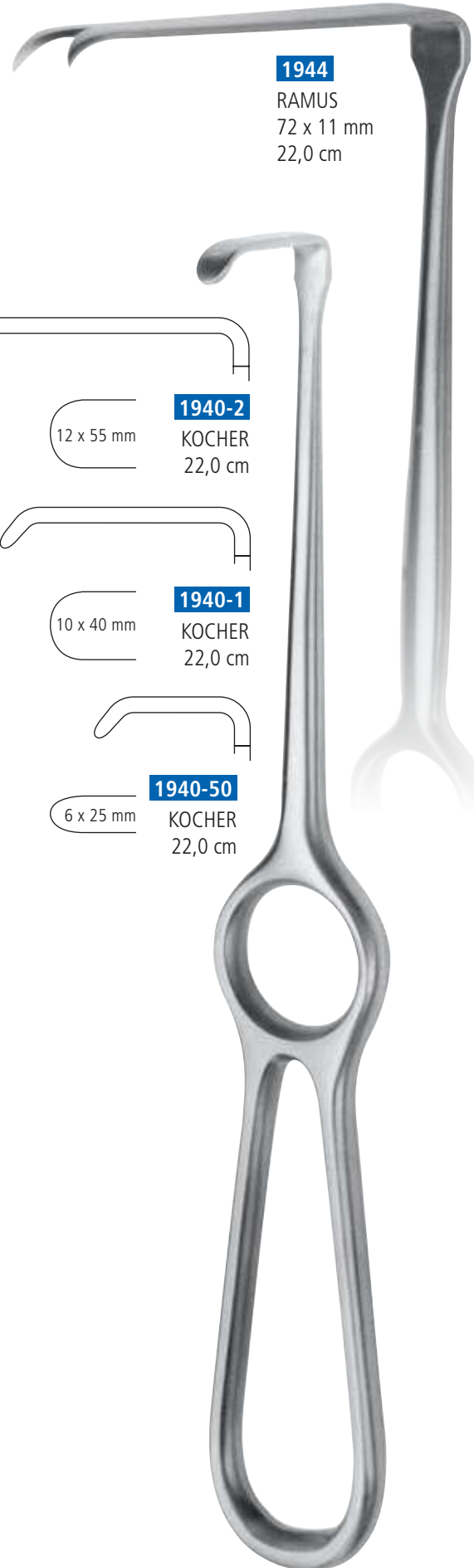

1944
RAMUS
72 x 11 mm
22,0 cm

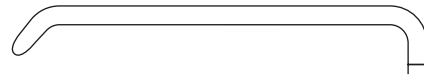

1940-2
12 x 55 mm KOCHER
22,0 cm

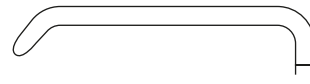

1940-1
10 x 40 mm KOCHER
22,0 cm

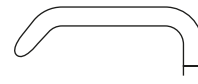

1940-50
6 x 25 mm KOCHER
22,0 cm



2. Chirurgie · Surgery

Universal Vestibulum Abhalter · Universal vestibulum retractors

84

i

MATY Abhalter MATY retractor

- Patientenfreundlich
- universell für OK und UK
- kein Herausnehmen bei Unterbrechung
- patient friendly
- universal maxilla / mandible
- no need to remove during interruptions



2510

15,0 cm

Universal Vestibulum Abhalter
Universal vestibulum retractor

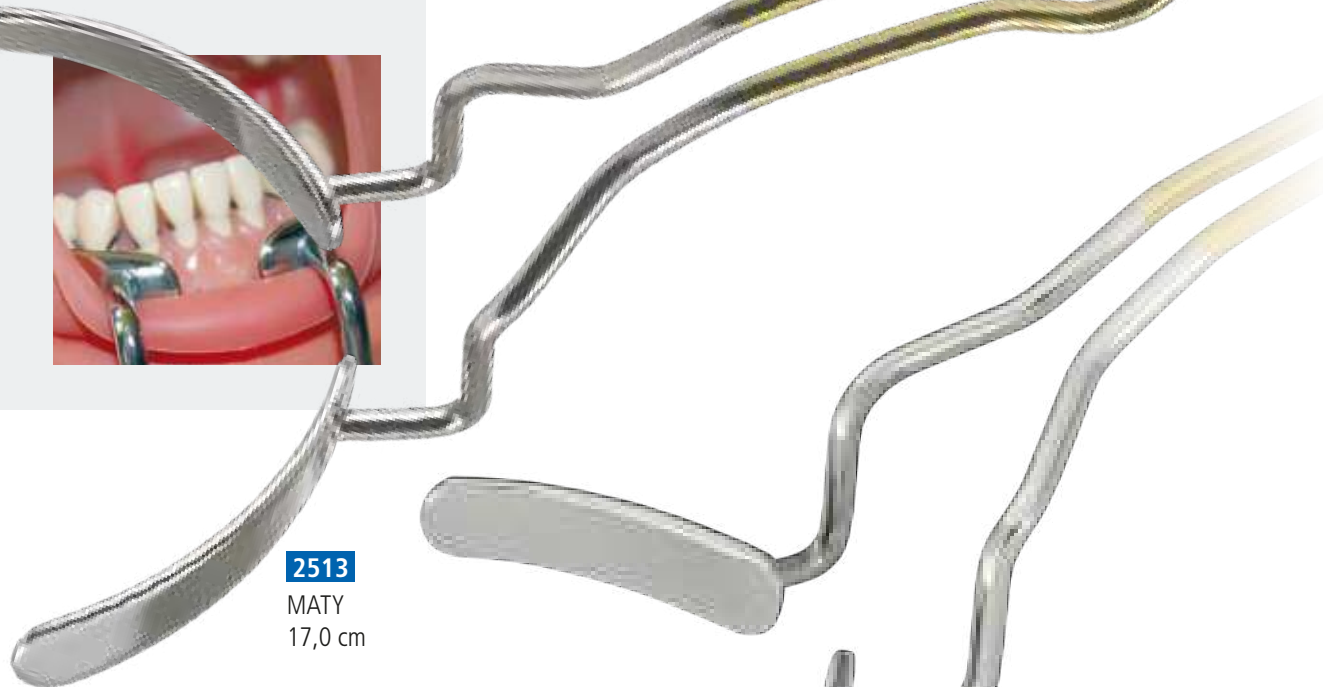

2513

MATY
17,0 cm



2514

MATY
16,0 cm
Kinder
children





i

KIM Retraktor · KIM retractor

Der Kim Retraktor eignet sich hervorragend für das Abhalten des Weichgewebes bei der 8er Extraktion.

Durch seine schlanke Form lässt sich das Instrument ideal in allen Quadranten positionieren. Die 45° Biegung in Verbindung mit der Mikroverzahnung lässt ein patientenfreundliches Abhalten ohne Abgleiten am Knochen zu.

The Kim retractor is excellent suited for keeping away the soft tissue during wisdom teeth extractions.

Due to its slim shape it is very easy to place the instrument in every area of the jaw. The 45° angle in combination with the micro serration allows a very patient friendly retracting without slipping away from the bone.



2450
HILGER



2781-4
12,5 cm



1933-1
KIM
10,5 mm breit, flach,
45° gewinkelt
10.5 mm width, flat,
45° angulated



1933-50
LASTER Spezialwundhaken
für obere impaktierte Weisheitszähne, Spitze
mikroverzähnt, 10 cm
LASTER special wound retractor
for upper impacted wisdom teeth, tip micro
serrated, 10 cm



2. Chirurgie · Surgery

Abhalter · Retractors



2502-1

MIDDELDORPF
17,0 cm

2502-2

MIDDELDORPF
22,0 cm



2462

STERNBERG
16,0 cm



2470

ROUX
17,0 cm



2204-1

MARKEL „S“
für Kleinkinder / Paar
for small children / pair



2204-2

MARKEL „M“
für Kinder / Paar
for children / pair

2204-3

MARKEL „L“
für Erwachsene / Paar
for adults / pair

86



2. Chirurgie · Surgery

Abhalter / Mundsperrer · Retractors / Mouth gags



SCHWERT
SWORD · ESPADA
EPEE · SPADA

87

Chirurgie
Surgery



i



2355

BRUENINGS
19,0 cm
Zungenandrücker
Tongue retractor



2460

**CAWOOD-
MINNESOTA**
16,0 cm

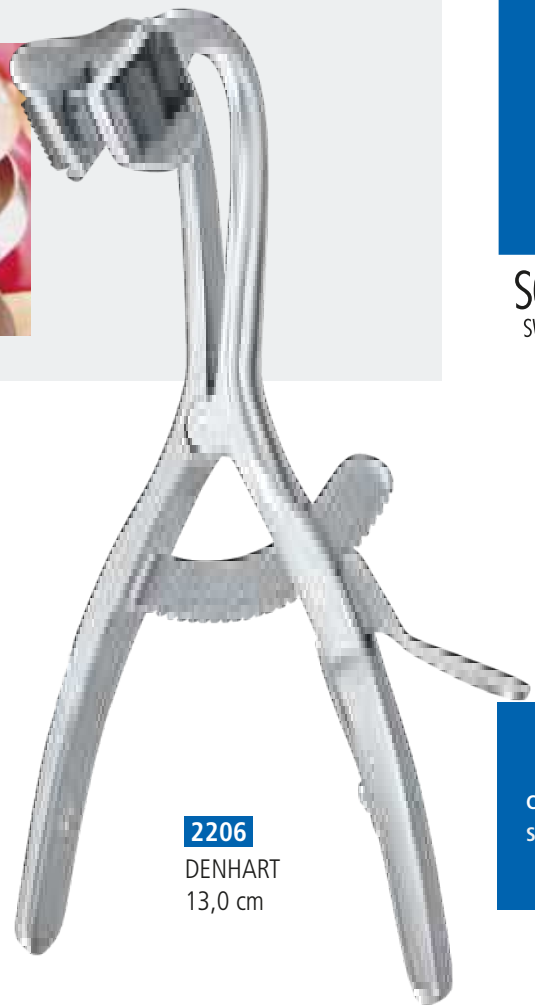

2206

DENHART
13,0 cm



4940-101

1 Paar Silikoneinlagen für **2206**
1 pair of silicone inserts for **2206**

2205-1

(ohne Abbildung · without illustration)
1 Paar Silikoneinlagen für **2205**
(**altes Modell**)
1 pair of silicone inserts for **2205**
(**old model**)

2. Chirurgie · Surgery

Mundsperrer · Mouth gags



SCHWERT
SWORD · ESPADA
EPEE · SPADA

88

i

ORINGER Lippen-sperrer & Wagen-abhalter
ORINGER Selfretraining cheek-lip retractor

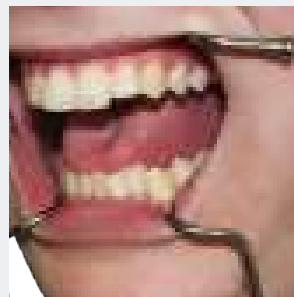

2465-1

ORINGER
klein
small

2465-2

ORINGER
mittel
medium

2465-3

ORINGER
groß
large



2237

MOLT
12,0 cm
für Kinder
for children

2237-1

1 Paar Silikonkappen für **2237**
1 pair of silicone inserts for **2237**

2238

MOLT
14,0 cm
für Erwachsene
for adults

2238-1

1 Paar Silikonkappen für **2238**
1 pair of silicone inserts for **2238**



2338-1

WIEDER
Zungen-Drücker
Tongue depressor
klein
small

2338-2

WIEDER
Zungen-Drücker
Tongue depressor
groß
large



2. Chirurgie · Surgery

Saugkanülen · Suction tubes



SCHWERT
SWORD · ESPADA
EPEE · SPADA

89

Chirurgie
Surgery



i

Chirurgischer Absauger,
rostfrei mit Schlitz im
Arbeitsende um Festsaugen
zu verhindern.
Anschluss Ø 6,0 mm.

Surgical suction tube,
stainless steel, with slot
at the working end in
order to prevent from
adhering during suction.
Connection Ø 6,0 mm.

2564-15

Ø 1,5 mm

2564-30

Ø 3,0 mm

2564-50

Ø 5,0 mm



2. Chirurgie · Surgery

Clips für Spülschlauch · Clips for rinsing hose



2563-20

Clip Set
ohne Absauger und Spülschlauch
without suction tube and rinsing hose



2563-21

Führungsclip
Guiding clip



2563-22

Stabilisierungsclip
Stabilization clip

90

i

Clips für Spülschlauch · Clips for rinsing hose

Ein großes und immer wiederkehrendes Problem bei allen zahnärztlichen Behandlungen und Operationen ist das geringe Platzangebot im Mund des Patienten. Oft ist es nötig Spülen und Absaugen in einem zu kombinieren. Hierfür wurde ein neues Clipsystem entwickelt, welches hervorragend auf unsere Saugansätze passt. So kann der Spülschlauch direkt am Absauger befestigt werden, was ein schnelles und präzises Arbeiten erlaubt.

Absaugen und Spülen in einem Schritt war noch nie so einfach! Die Kunststoffclips sind wiederverwendbar und für die Dampfsterilisation geeignet.

A serious and always returning problem within all dental treatments and operations is the low amount of space in the patient's mouth. Often it is necessary to combine flushing and suctioning. Especially for that reason we created a new clip system, which fits perfectly onto our suction tubes. By that it is easy to fix the flushing tube directly at the suction tube, which allows a fast and precise work.

Suctioning and flushing, all in one, was never easier! The plastic clips are re-usable and are appropriate for steam sterilization.



2. Chirurgie · Surgery

Saugkanülen · Suction tubes



SCHWERT
SWORD · ESPADA
EPEE · SPADA

91

Chirurgie
Surgery



2559-1

FRAZIER
Ø 2,0 mm
18,0 cm

2559-2

FRAZIER
Ø 3,0 mm
18,0 cm

2562-1

MATY
Chirurgischer Absauger
Titanspitze, geschlitzt,
Ø 1,5 mm
Surgical aspirator with slot,
titanium tip, Ø 1.5 mm

2562-2

MATY
Chirurgischer Absauger
Titanspitze, geschlitzt,
Ø 3,0 mm
Surgical aspirator with
slot, titanium tip,
Ø 3.0 mm

Anschluss
Ø 6,0 mm
Connection
Ø 6.0 mm



2. Chirurgie · Surgery

Nadelhalter · Needle holder

i

SCHWERT TC · SCHWERT TC

TC Nadelhalter

- sehr lange Lebensdauer durch Hartmetalleinsätze in beiden Backen
- Goldmarkierung an beiden Griffen

TC Needle holders

- long durability due to Tungsten Carbide inserts on both jaws
- both handles gold coated

92



2054
MATHIEU
17,0 cm



2058
MATHIEU TC
17,0 cm



2056
MATHIEU
17,0 cm

Fadenstärke
Suture size



2059
LICHTENBERG-
RYDER TC
14,0 cm



2059-17
LICHTENBERG-
RYDER TC
17,0 cm



2059-14
LICHTENBERG-
RYDER TC
14,0 cm



2059-1
LICHTENBERG-
RYDER TC
17,0 cm

i

LICHTENBERG-RYDER LICHTENBERG-RYDER

- grazil ausgearbeitete Arbeitsenden
- besonders leichtgängig
- fine working tips
- smooth handling



2. Chirurgie · Surgery

Nadelhalter · Needle holder



SCHWERT
SWORD · ESPADA
EPEE · SPADA

93

Chirurgie
Surgery



2052

MATHIEU
14,0 cm



2053

MATHIEU
14,0 cm



2057

MATHIEU **TC**
14,0 cm

3/0 - 4/0



2035

TÖNNIS **TC**
18,0 cm

3/0 - 4/0



2. Chirurgie · Surgery

Nadelhalter · Needle holders

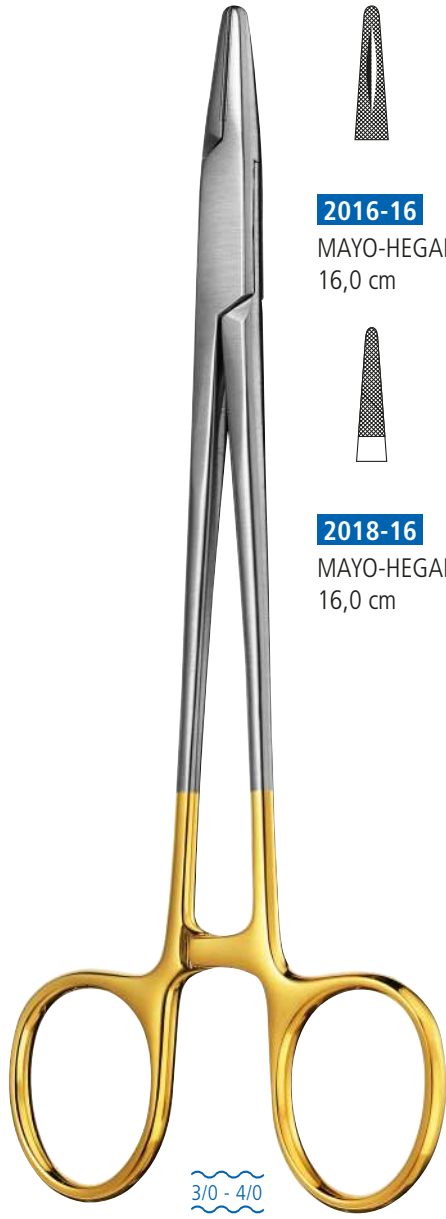

2016-16

MAYO-HEGAR
16,0 cm



2016-18

MAYO-HEGAR
18,0 cm



2018-16

MAYO-HEGAR TC
16,0 cm



2018-18

MAYO-HEGAR TC
18,0 cm



2012

CRILE-WOOD
15,0 cm



2014

CRILE-WOOD TC
15,0 cm



Fadenstärke
Suture size



2. Chirurgie · Surgery

Nadelhalter · Needle holder



SCHWERT
SWORD · ESPADA
EPEE · SPADA

95

Chirurgie
Surgery



2011

BAUMGARTNER TC
13,0 cm

3/0 - 4/0

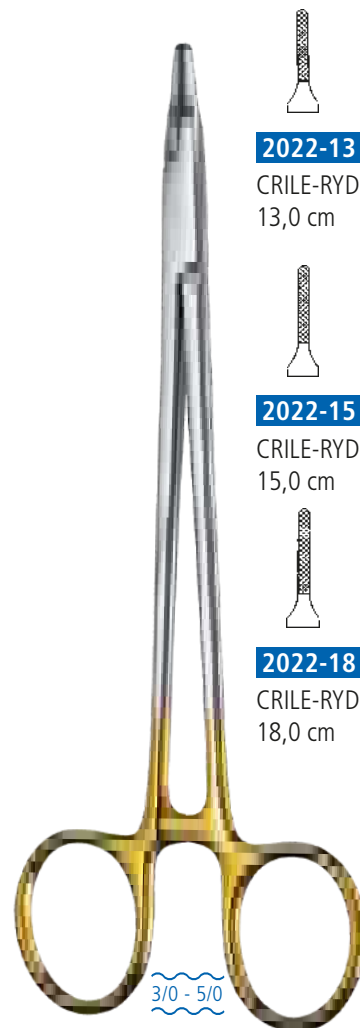

2022-13

CRILE-RYDER TC
13,0 cm

2022-15

CRILE-RYDER TC
15,0 cm

2022-18

CRILE-RYDER TC
18,0 cm

3/0 - 5/0



2. Chirurgie · Surgery

Nadelhalter · Needle holder

SCHWERT
SWORD · ESPADA
EPEE · SPADA

96



2020-16

DE BAKEY **TC**
16,0 cm



2020-18

DE BAKEY **TC**
18,0 cm



2023-15

Schwedisches Modell
Swedish pattern

TC
15,0 cm

sehr fein
very fine

Fadenstärke
Suture size

2. Chirurgie · Surgery

Zubehör · Accessories



SCHWERT
SWORD · ESPADA
EPEE · SPADA

97

Chirurgie
Surgery



2616-25

Medizinbecher, 25 ccm,
rostfrei
Medicine cup, 25 ccm,
stainless steel

2616-140

Medizinschale, rostfrei Ø 80 mm
x 40 mm Höhe, Inhalt 0,14 l
Medicine bowl, stainless steel, Ø 80 mm
x 40 mm height, contents 0,14 l



2040

100 cm
Fraktur- / Splintschiene
Fracture banding-splint with hooks



2024

TC 15,0 cm
Drahtspannzange
For wire ligatures



1:2

2619-2

245 x 120 x 40 mm
Nierenschale
Kidney bowl



2. Chirurgie · Surgery

Zylinderampullenspritzen · Cartridge syringes



2666-18

1,8 ccm
Metrisches Gewinde
Metric thread
Ohne Aspiration*
Without aspiration device*

2666-18US

1,8 ccm
US-Gewinde
US-thread
Ohne Aspiration*
Without aspiration device*

2666-22US

2,2 ccm
US-Gewinde
US-thread
Ohne Aspiration*
Without aspiration device*

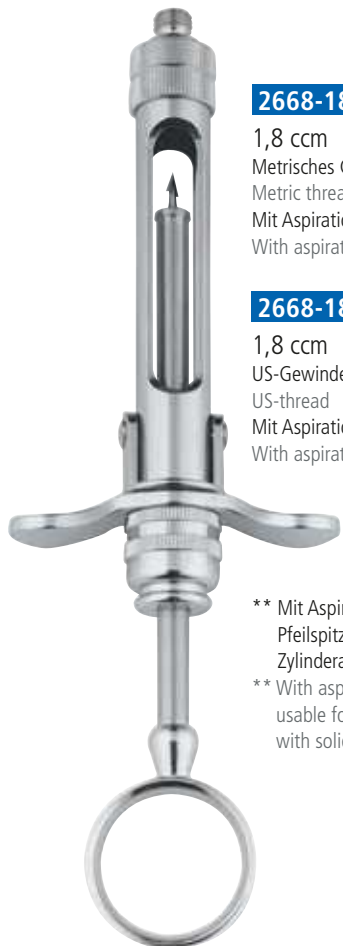

2668-18

1,8 ccm
Metrisches Gewinde
Metric thread
Mit Aspiration**
With aspiration device**

2668-18US

1,8 ccm
US-Gewinde
US-thread
Mit Aspiration**
With aspiration device**

** Mit Aspiration durch Pfeilspitze, verwendbar mit Zylinderampulle: Vollstopfen
** With aspiration by arrowhead, usable for all dental cartridges with solid plug



2669-18

1,8 ccm
Metrisches Gewinde
Metric thread
Mit Aspiration durch drei seitliche Haken, verwendbar mit Zylinderampulle: Lochstopfen
With aspiration by three lateral hooks, usable for all dental cartridges with hole plug

* Ohne Aspiration, verwendbar mit Zylinderampulle: Vollstopfen und Lochstopfen
* Without aspiration, usable for all dental cartridges with solid plug or hole plug



2716

10,0 ccm
Wasserspritze selbstbefüllend
Water syringe aspirating

2702-09

Ersatzkanüle
Spare canula

98



2. Chirurgie · Surgery

Messschieber / Metall Lineal · Caliper / Metal ruler



SCHWERT
SWORD · ESPADA
EPEE · SPADA

99

Chirurgie
Surgery

i

Messschieber
Caliper



1732
10,0 cm

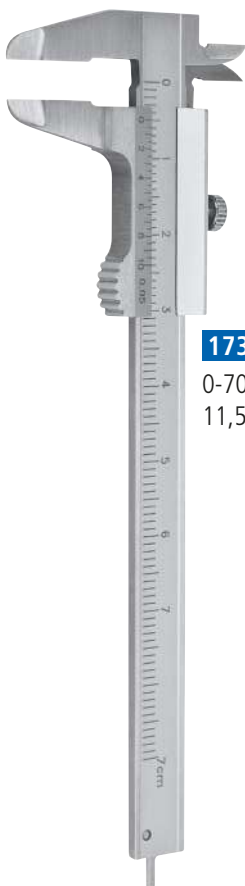

1730-8
0-70 mm
11,5 cm

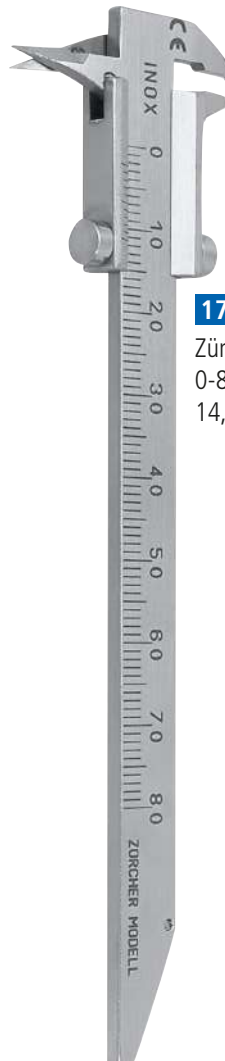

1730-7
Zürcher Modell
0-80 mm
14,0 cm

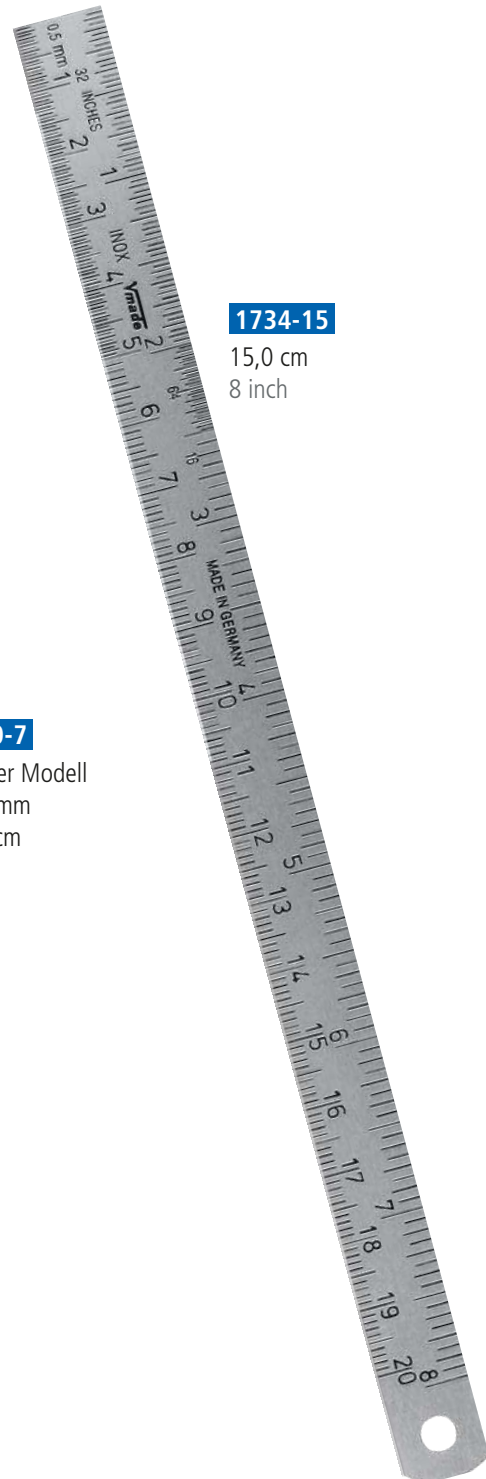

1734-15
15,0 cm
8 inch



2. Chirurgie · Surgery

Chirurgie Basis Set · Surgical basic kit

i

Chirurgie Basis Set · Surgical basic kit

Mit dem Chirurgie Basis Set erhalten Sie ein kostengünstiges hochwertiges Instrumentarium, womit alle chirurgischen Eingriffe durchgeführt werden können.

With the surgical basic kit you get a cost saving high quality armamentarium for all surgical treatments.

100

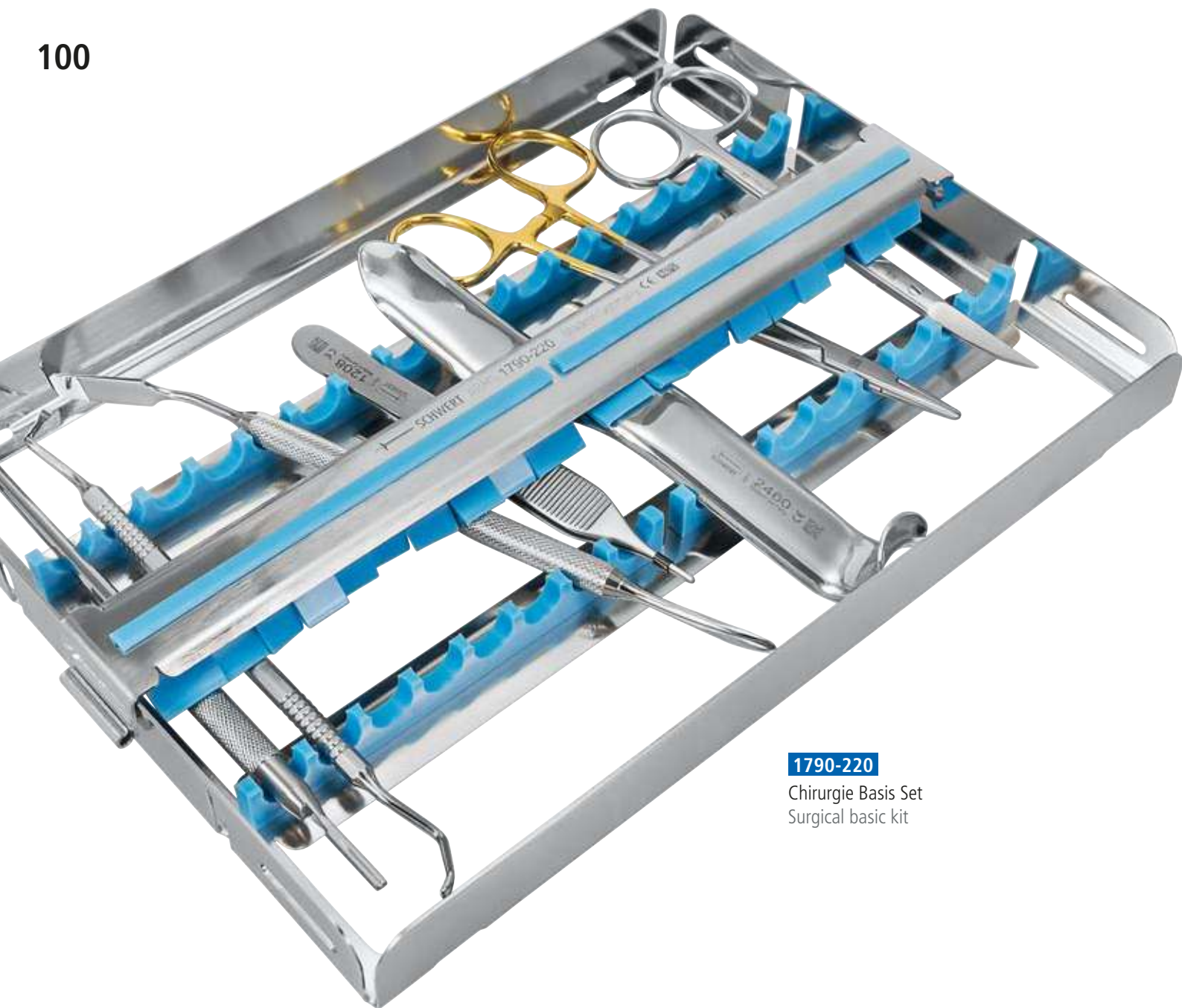

1790-220

Chirurgie Basis Set
Surgical basic kit



2. Chirurgie · Surgery









Chirurgie Basis Set · Surgical basic kit

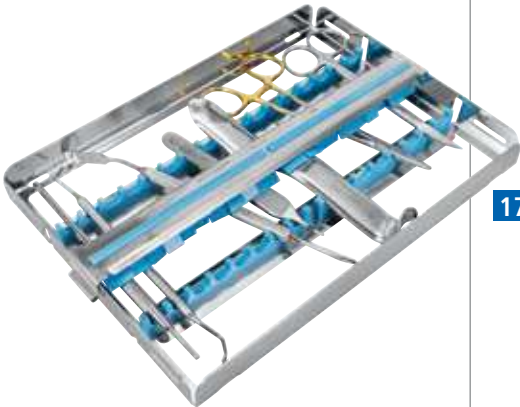

SCHWERT
SWORD · ESPADA
EPEE · SPADA

101

Chirurgie
Surgery

	Artikel-Nr. Item-No.	Artikelbeschreibung Description
	<p>1790-220</p>	<p>Chirurgie Basis Set bestehend aus: Surgical basic kit consisting of</p>
	<p>1033-1 Seite / Page 54</p>	<p>Skalpellgriffe rund, gerade, 16 cm Scalpel handle round, straight, 16 cm</p>
	<p>1125 Seite / Page 60</p>	<p>JOSEPH Zahnfleischschere, gebogen, 14 cm JOSEPH Gum scissors, curved, 14 cm</p>
	<p>1208 Seite / Page 70</p>	<p>ADSON chirurgische Pinzette 1 x 2 Zähne, 12 cm ADSON Tissue forceps, 1 x 2 teeth, 12 cm</p>
	<p>1405 Seite / Page 77</p>	<p>PRICHARD Raspatorium, 18 cm PRICHARD Periosteal elevator, 18 cm</p>
	<p>2014 Seite / Page 94</p>	<p>CRILE-WOOD TC Nadelhalter, 15 cm CRILE-WOOD TC Needle holder, 15 cm</p>
	<p>2460 Seite / Page 87</p>	<p>MINNESOTA Zungen- und Wangenabhalter, 16 cm MINNESOTA Tongue/cheek retractor, 16 cm</p>
	<p>1371-1 Seite / Page 74</p>	<p>LUCAS scharfer Löffel, Ø 2,5mm, 17 cm LUCAS Bone curettes, Ø 2,5mm, 17 cm</p>
	<p>2599-20 Seite / Page 232</p>	<p>Waschtray für 16 Instrumente mit Silikonauflage und Fixierclip 26 x 18 x 2,7 cm Wash - tray for 16 Instruments with silicon rest and fixing clip 26 x 18 x 2,7 cm</p>

2. Chirurgie · Surgery

SCHWERT DESIGN Chirurgie Set · SCHWERT DESIGN surgical kit

i

SCHWERT DESIGN Chirurgie Set SCHWERT DESIGN surgical kit

Mit dem erweiterten chirurgie Set im SCHWERT DESIGN erhalten Sie ein optimal auf alle chirurgischen Eingriffe abgestimmtes Instrumentarium, dass keine Wünsche an Ergonomie und Funktion offen lässt.

With the extended SCHWERT DESIGN surgical kit you get an armamentarium for all surgical treatments which leaves nothing to be desired when it comes to ergonomic and functional work.

102

SCHWERT
SWORD · ESPADA
EPEE · SPADA

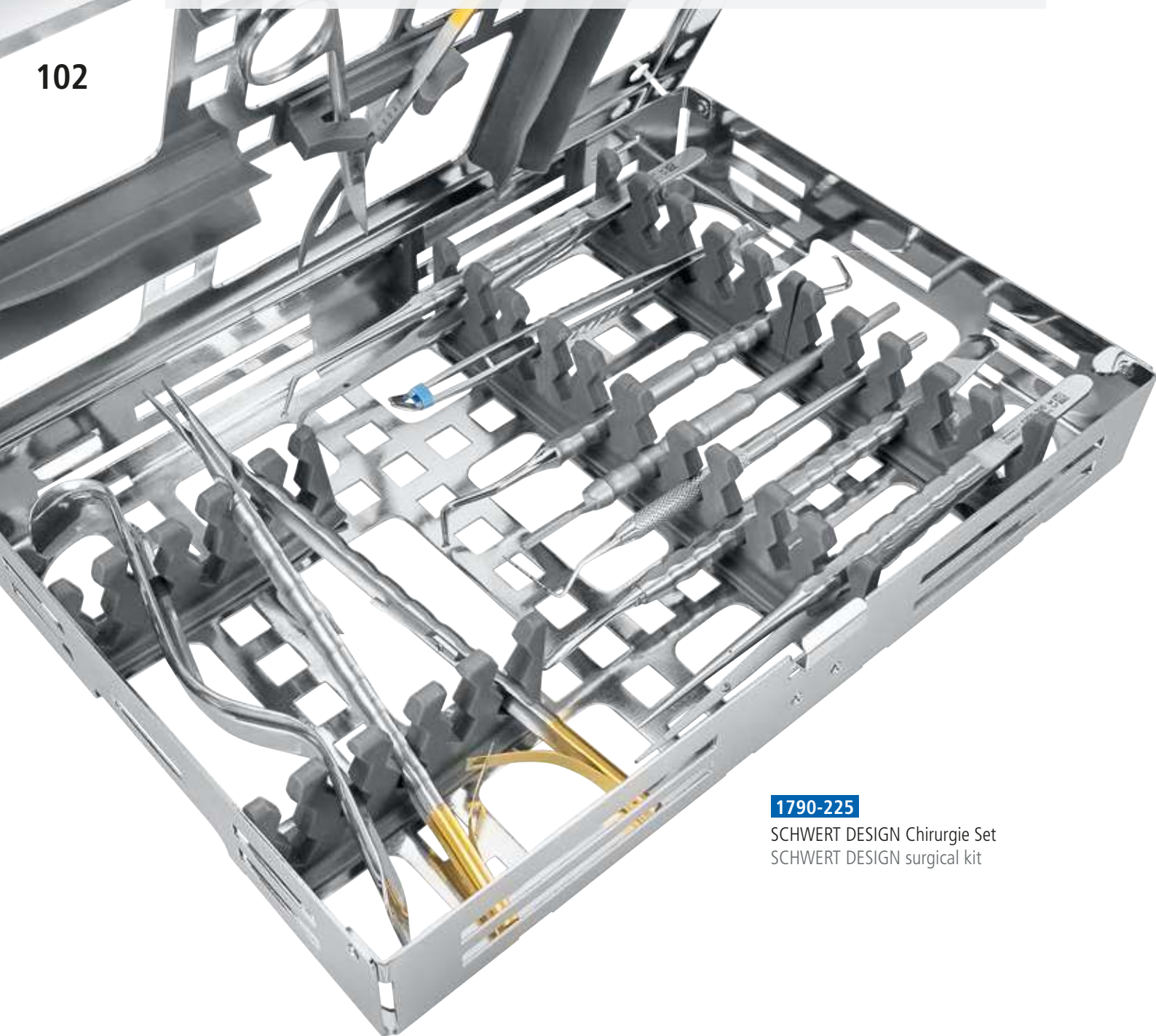

1790-225

SCHWERT DESIGN Chirurgie Set
SCHWERT DESIGN surgical kit

2. Chirurgie · Surgery

SCHWERT DESIGN Chirurgie Set · SCHWERT DESIGN surgical kit



Artikel-Nr.
Item-No.

Artikelbeschreibung
Description

1790-225

SCHWERT DESIGN Chirurgie Set bestehend aus:
SCHWERT DESIGN surgical kit consisting of



1033-60



Seite / Page 52

SAFE-EX Sicherheitsklingenhalter, zerlegbar, 15 cm
SAFE-EX Safety blade holder, dismantlable, 15 cm



1125-400

Seite / Page 60

JOSEPH  Zahnfleischschere, gebogen, 14 cm
JOSEPH  Gum scissors, curved, 14 cm



1208-300

Seite / Page 108

Mikro-Pinzette, gerade mit Führungsstift, 1x2 Zähne, rostfrei, SCHWERT DESIGN, 17,5 cm
Micro Forceps, straight with guiding pin, 1x2 teeth, stainless steel, SCHWERT DESIGN, 17,5 cm



1208-355

Seite / Page 109

Mikro-Nahtpinzette gebogen, Ø Ring: 2,0 mm, SCHWERT Design, 17,5 cm
Micro Suture-Forceps, curved, Ø ring: 2,0 mm, SCHWERT DESIGN, 17,5 cm



1372-1

Seite / Page 75

LUCAS Kürette, ungezahnt, 2,5 mm, SCHWERT DESIGN, 17,5 cm
LUCAS Curette, double ended, 2,5 mm, SCHWERT DESIGN, 17,5 cm



1411-08

Seite / Page 111

PRICHARD Raspatorium, auswechselbar, SCHWERT DESIGN, 17,5 cm
PRICHARD Periosteal elevator, exchangeable tips, SCHWERT DESIGN, 17,5 cm



2000-60

Seite / Page 111

 Mikro Nadelhalter mit Schloss, 17,5 cm
 Micro Needle holder with lock, 17,5 cm



2460

Seite / Page 87

MINNESOTA Zungen- und Wangenabhalter, 16 cm
MINNESOTA Tongue/cheek retractor, 16 cm



2887

Seite / Page 149

COLLEGE Zahnpinzette, 15 cm
COLLEGE Tooth forceps, 15 cm



3418-15

Seite / Page 154

NORTH-CAROLINA Parodontal-Sonde, Fig. CP15, 15 cm
NORTH-CAROLINA Periodontal probe, Fig. CP15, 15 cm

2610-1

Seite / Page 235

SCHWERT- Protector 1/1 mit Stegen und Instrumentenhalter im Deckel 266 x 180 x 36 mm
SCHWERT-Tray with racks and Instrument holder in the lid 266 x 180 x 36 mm



SCHWERT
SWORD · ESPADA
EPEE · SPADA

103

Chirurgie
Surgery



2. Chirurgie · Surgery

SCHWERT DESIGN Griffe · SCHWERT DESIGN handles



104

i

SCHWERT DESIGN · SCHWERT DESIGN

Der SCHWERT DESIGN Griff wurde entwickelt, um dem Behandler ein hygienisch einfach zu pflegendes, funktionelles Instrument in die Hand zu geben.

Die Oberflächen wurden wo sinnvoll satiniert um Lichtreflexionen zu minimieren. Speziell die chirurgischen Arbeitsenden wurden in Hochglanz gehalten, damit diese Flächen effizient von Blut und Weichgewebsresten gereinigt werden können.

Der Runde Griff erlaubt ein ergonomisch einwandfreies Arbeiten. Die Planflächen verhindern das Wegrollen der Instrumente auf dem OP-Tisch.

The SCHWERT DESIGN handle have been developed for offering a hygienic simple to clean and perfect working instrument for the surgeon.

The surfaces are satin finished where appropriate for reducing light reflections. Especially the surgical working ends are equipped with a mirror finished surface, thus they are efficient to clean, for removing blood and soft tissue residues.

The round handle provides an ergonomic perfect work result. The plane surface on the handle avoids the rolling away on the surgical tray.

2. Chirurgie · Surgery

SAFE-EX Sicherheitsklingenhalter · SAFE-EX Safety blade holder



SCHWERT
SWORD · ESPADA
EPEE · SPADA

105

Chirurgie
Surgery



SAFE-EX
patented



1033-50

Edelstahl,
ergonomische Form
Stainless steel,
ergonomic shape



1033-60

Sicherheits-
klingenhalter,
ergonomische Form,
zerlegbar
Safety blade holder,
ergonomic shape,
dismountable

2. Mikrochirurgie · Microsurgery

Mikro Skalpellklingen / Skalpellgriffe / Scheren · Micro scalpel blades / Scalpel handles / scissors



Weitere Figuren
auf Anfrage.
Further figures
per request.



1070-64*

FIG. 64
3,2 cm
10 Stk., **steril**
10 pcs., **sterile**



1070-67*

FIG. 67
3,2 cm
10 Stk., **steril**
10 pcs., **sterile**



1070-69*

FIG. 69
3,2 cm
10 Stk., **steril**
10 pcs., **sterile**

106



1070-00

Ergonomisch, Titan
Ergonomic, titanium



1071-13

13,0 cm



1071-15

15,0 cm



1135-15

MICRO
15,0 cm
gerade
straight

1136-15

MICRO
15,0 cm
gebogen
curved

2. Mikrochirurgie · Microsurgery

Mikro Scheren · Micro scissors



SCHWERT
SWORD · ESPADA
EPEE · SPADA

107

Mikrochirurgie
Microsurgery

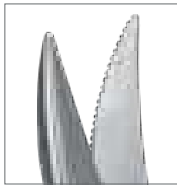

1135-17

MICRO
17,5 cm
Ø 8,0 mm
mikroverzahnt,
gebogen
micro serrated,
curved



1136-17

MICRO
17,5 cm
Ø 8,0 mm
gebogen
curved

fein
fine



1137-17

MICRO
17,5 cm
Ø 8,0 mm
gebogen
curved

sehr fein
very fine





2. Mikrochirurgie · Microsurgery

Mikro Pinzetten · Micro forceps

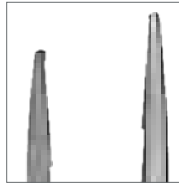

1208-300

1x2 Zähne
1x2 teeth
17,5 cm

mit Fadenplatte*
with suture plate*

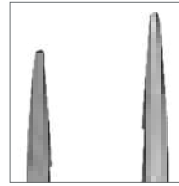

1208-320

glatt
smooth
17,5 cm

mit Fadenplatte*
with suture plate*

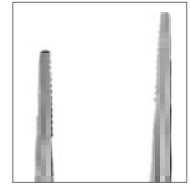

1208-340

COOLEY
17,5 cm

Atraumatische Spitzen, ideal
zum Greifen und Halten von
Weichgewebe geeignet
Due to atraumatic tips, per-
fectly suited for grasping and
holding soft tissue

*Mikro-Chirurgische Pinzetten mit Fadenplatte. Die Mikro-Zähnen dienen zum Halten des Mucoperiostlappens beim chirurgischen Eingriff. Mit der hinter den Zähnen angeordneten Fadenplatte kann der Chirurg den Mikrofadensicher beim Nähen führen.

*Micro surgical tweezers with suture plate. The micro teeth securely hold the mucoperiostal flap. With the suture plate behind the micro teeth the surgeon securely can guide the suture while suturing.



2. Mikrochirurgie · Microsurgery

Mikro Pinzetten · Micro forceps



1208-305

1x2 Zähne
1x2 teeth
17,5 cm

mit Fadenplatte*
with suture plate*

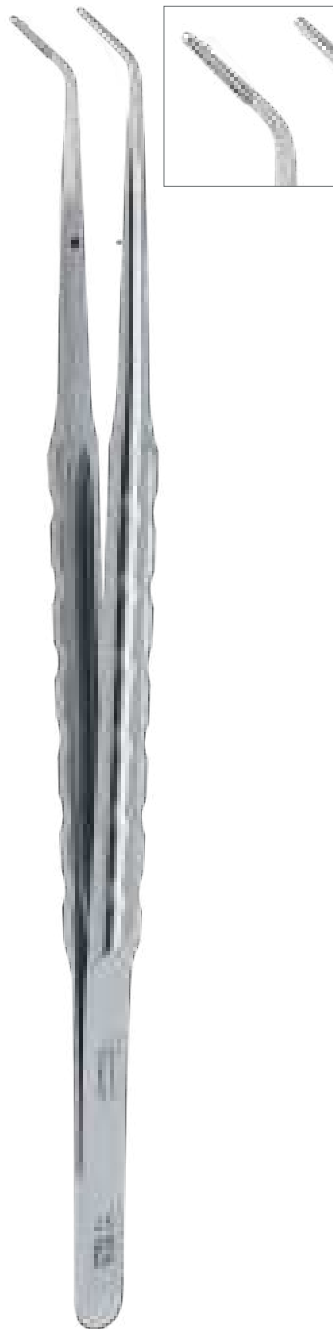

1208-345

COOLEY
17,5 cm

Atraumatische Spitzen, ideal zum Greifen und Halten von Weichgewebe geeignet
Due to atraumatic tips, perfectly suited for grasping and holding soft tissue

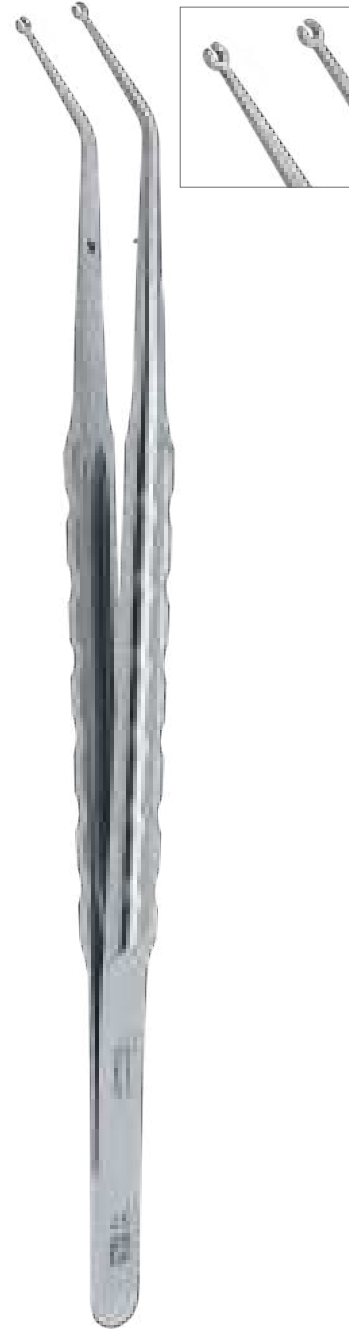

1208-355

Ø Ring: 2,0 mm
Ø ring: 2,0 mm
17,5 cm

Mikro Nahtpinzette
Micro suture forceps



SCHWERT
SWORD · ESPADA
EPEE · SPADA

109

Mikrochirurgie
Microsurgery



2. Mikrochirurgie · Microsurgery

Raspatorien · Periosteals

SCHWERT
SWORD · ESPADA
EPEE · SPADA

110



1411-01
MOLT
2,5 / 4,0 mm
17,5 cm



1411-07
2,6 / 2,6 mm
17,5 cm
fein
fine



1411-04
MICRO-BUSER
2,4 / 2,8 mm
17,5 cm



1411-05
BUSER
3,8 / 4,2 mm
17,5 cm



1411-06
BUSER
3,8 / 4,2 mm
17,5 cm
gebogen
curved



1411-03
GLICKMANN
FIG. 24G
17,5 cm



2. Mikrochirurgie · Microsurgery

SCHWERT **twist** Nadelhalter · SCHWERT **twist** Needle holder



SCHWERT
SWORD · ESPADA
EPEE · SPADA

111

Mikrochirurgie
Microsurgery

i

SCHWERT **twist** Serie SCHWERT **twist** series

Die SCHWERT **twist** Instrumente mit gedrehtem Schluss vermeiden zuverlässig ein Verfangen des Fadens während des Knüpfens.

The SCHWERT **twist** instruments with the twisted lock avoid reliably sticking of the suture while knotting.



1411-02

1,8 / 3,4 mm
17,5 cm
Dissektion /
Raspatorium
Dissection /
periosteal
auswechselbar
exchangeable



1411-08

PRICHRAD
17,5 cm
Spatel / 4,0 mm
Raspatorium
Spatula / 4,0 mm
periosteal
auswechselbar
exchangeable



2000-60

twist TC

Mikro Nadelhalter
mit Schloss, 17,5 cm
Micro Needle holder
with lock, 17.5 cm

2000-66

twist TC

Mikro Nadelhalter
mit Schloss, 17,5 cm
Micro Needle holder
with lock, 17.5 cm

4/0 - 8/0



2. Mikrochirurgie · Microsurgery

SCHWERT **twist** Nadelhalter · SCHWERT **twist** Needle holder

i







SCHWERT **twist** Serie SCHWERT **twist** series

Die SCHWERT **twist** Instrumente mit gedrehtem Schluss vermeiden zuverlässig ein Verfangen des Fadens während des Knüpfens.

The SCHWERT **twist** instruments with the twisted lock avoid reliably sticking of the suture while knotting.



112

 <p>2000-10 twist TC Mikro Nadelhalter mit Schloss, 17,5 cm Micro Needle holder with lock, 17.5 cm</p> <p>5/0 - 8/0</p>	 <p>2000-16 twist TC Mikro Nadelhalter mit Schloss, 17,5 cm Micro Needle holder with lock, 17.5 cm</p> <p>5/0 - 8/0</p>	 <p>2000-201 BARRAQUER 18,0 cm</p>  <p>2000-206 BARRAQUER 18,0 cm</p>  <p>2000-21 BARRAQUER TC 18,0 cm</p>  <p>2000-26 BARRAQUER TC 18,0 cm</p>
		<p> Diamantiert Diamond coating</p>

Fadenstärke
Suture size

2. Mikrochirurgie · Microsurgery

Mikro Nadelhalter · Micro needle holders



SCHWERT
SWORD · ESPADA
EPEE · SPADA

113

Mikrochirurgie
Microsurgery



5/0 - 8/0



2001-1

CASTROVIEJO
14,0 cm



2001-6

CASTROVIEJO
14,0 cm



2002-1

CASTROVIEJO **TC**
14,0 cm



2002-6

CASTROVIEJO **TC**
14,0 cm



5/0 - 8/0



2000-1

MICRO **TC**
13,0 cm



2000-6

MICRO **TC**
13,0 cm



2000-51

MICRO **TC**
18,0 cm



2000-56

MICRO **TC**
18,0 cm



5/0 - 8/0

2. Mikrochirurgie · Microsurgery

Tunnelier Instrumente · Tunneling instruments

i

Tunnelier Instrumente · Tunneling instruments

In der Parodontologie finden die Tunnelierinstrumente Einsatz zur Präparation von Spalt- und Vollflappen, für spätere Kammaufbauten oder zur Deckung von Rezessionen mit Bindegewebe-Transplantat.

Die SCHWERT Tunnelierinstrumente erlauben eine minimalinvasive unterminierende Präparation, um große Aufklappungen zu vermeiden.

Instruments for the tunneling technique facilitates access and allowing a secure and atraumatic mucosal flap preparation.

The SCHWERT Tunneling instruments allow minimally invasive preparation to avoid big soft tissue flaps.

114



1705-210

1705-211

1705-2 Tunneliermesser FIG. 1, 1,9 / 2,5 mm, Oberkiefer, auswechselbar
Tunneling knife FIG. 1, 1.9 / 2.5 mm, maxilla, exchangeable



1705-310

1705-311

1705-3 Tunneliermesser FIG. 2, 1,9 / 2,5 mm, Unterkiefer, auswechselbar
Tunneling knife FIG. 2, 1.9 / 2.5 mm, mandible, exchangeable



1705-4 Mucoperiostalelevator
Micro flap elevator



1705-110

1705-112

1705-15 Papillenheber, 1,5 / 2,5 mm, 17,5 cm, auswechselbar
Papilla elevator, 1.5 / 2.5 mm, 17.5 cm, exchangeable

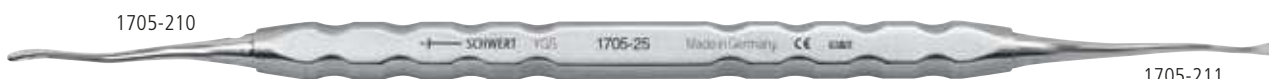

1705-210

1705-211

1705-25 Tunneliermesser FIG. 1, 1,9 / 2,5 mm, Oberkiefer, 18,0 cm, auswechselbar
Tunneling knife FIG. 1, 1.9 / 2.5 mm, maxilla, 18.0 cm, exchangeable



1705-310

1705-311

1705-35 Tunneliermesser FIG. 2, 1,9 / 2,5 mm, Unterkiefer, 18,0 cm, auswechselbar
Tunneling knife FIG. 2, 1.9 / 2.5 mm, mandible, 18.0 cm, exchangeable

2. Mikrochirurgie · Microsurgery

Tunnelier Instrumente · Tunneling instruments



SCHWERT
SWORD · ESPADA
EPEE · SPADA

115

Mikrochirurgie
Microsurgery

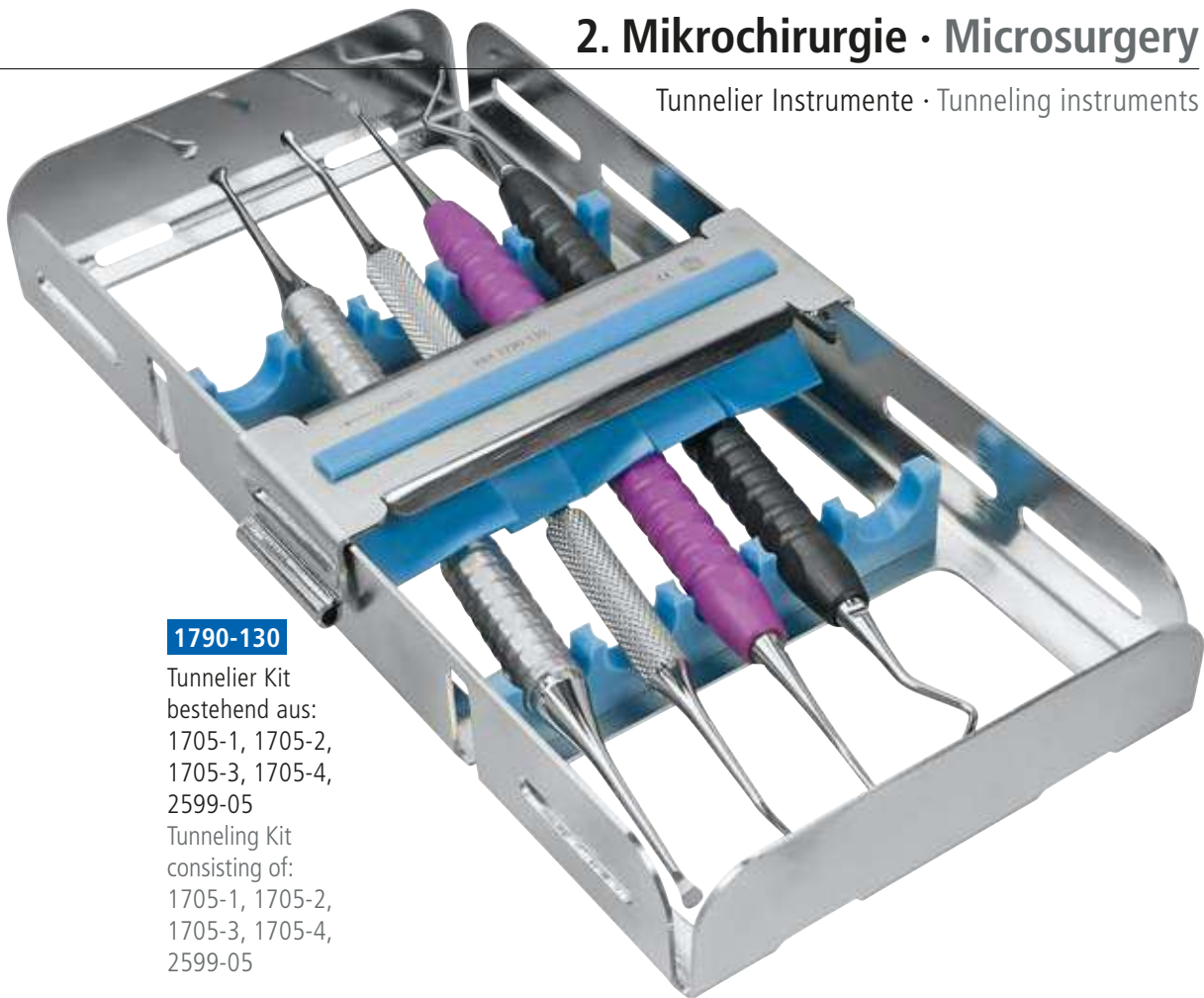

1790-130

Tunnelier Kit
bestehend aus:
1705-1, 1705-2,
1705-3, 1705-4,
2599-05

Tunneling Kit
consisting of:
1705-1, 1705-2,
1705-3, 1705-4,
2599-05

1705-510



1705-511

1705-55

Orbanmesser modifiziert für die Tunnelier-Technik
Orban knife, modified for tunneling technique

Spezielle Biegungen der Arbeitsenden und die feine Pfeilspitze ermöglichen eine einfache Tunnelpräparation an den schwer zugänglichen Seitenzahnbereichen.

Special bendings of the working tips and the fine arrow tip allow an easy tunnel preparation at the posterior region which are usually difficult to access.

1705-611



1705-610

1705-65

Parodontal Messer KGF8 modifiziert für die Tunnel-Technik
Periodontal knife KGF8 modified for tunneling technique

Abgewinkelte und im vorderen Drittel, leicht gebogene Arbeitsenden erleichtern den Zugang und ermöglichen dadurch, ein ideales Tunnelierergebnis im Seitenzahnbereich.

Bent and in the first third, slightly curved working tips, facilitate the access and allow due to that an ideal tunneling result in the posterior region.

1705-711



1705-710

1705-75

Parodontal Messer Fig. 1 gerade / gebogen
Periodontal knife Fig. 1 straight / curved

Leicht gebogenes Arbeitsende für den ersten initialen Zugang im Frontzahnbereich. Mit der Lanzenförmigen Spitze kann dann weiter dissektiert werden.

Slightly curved working tip for the initial access in the front teeth area. With the lance-shaped tip it is then easy to perform the dissection.

2. Mikrochirurgie · Microsurgery

SCHWERT DESIGN Mikro Tunnelier Set · SCHWERT DESIGN Micro tunneling kit

i

SCHWERT DESIGN Mikro Tunnelier Set SCHWERT DESIGN Micro tunneling kit

Mit dem erweiterten Mikro Tunnelier Set im SCHWERT DESIGN erhalten Sie ein komplettes auf die Tunneltechnik abgestimmtes Instrumentarium, dass keine Wünsche an Ergonomie und Funktion offen lässt.

With the extended SCHWERT DESIGN micro tunneling kit you get an armamentarium for tunnel technic which leaves nothing to be desired when it comes to ergonomic and functional work.

116

1790-240

SCHWERT DESIGN Mikro Tunnelier Set
SCHWERT DESIGN Micro tunneling kit

2. Mikrochirurgie · Microsurgery

SCHWERT DESIGN Mikro Tunnelier Set · SCHWERT DESIGN Micro tunneling kit

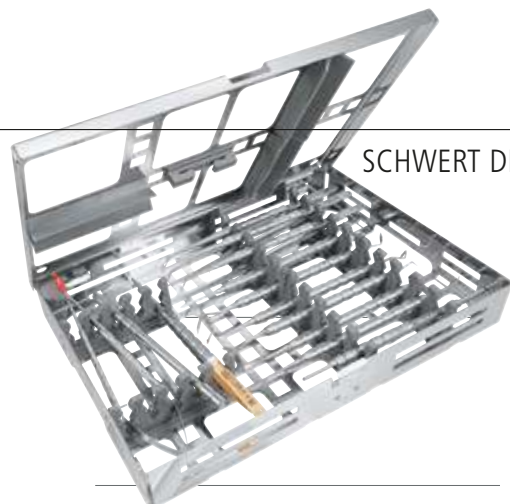

Artikel-Nr.
Item-No.

Artikelbeschreibung
Description

1790-240

SCHWERT DESIGN Mikro Tunnelier Set bestehend aus:
SCHWERT DESIGN Micro tunneling kit consisting of

1033-60

Seite / Page 52

SAFE-EX Sicherheitsklingenhalter, zerlegbar, 15 cm
SAFE-EX Safety blade holder, dismountable, 15 cm

1136-17

Seite / Page 107

Mikro-Schere, Mikroverzahnung, spitz/spitz, gebogen,
Ø 8 mm, SCHWERT DESIGN, 17 cm
Micro scissors, micro serrated, pointed/pointed, curved,
Ø 8mm, SCHWERT DESIGN, 17 cm

1070-00

Seite / Page 106

Mikro-Skalpellgriff, Titan, SCHWERT DESIGN, 13 cm
Micro-Scalpel handle, Titanium, SCHWERT DESIGN, 13 cm

1208-300

Seite / Page 108

Mikro-Pinzette, gerade mit Führungsstift, 1x2 Zähne,
rostfrei, SCHWERT DESIGN, 17,5 cm
Micro Forceps, straight with guiding pin, 1x2 teeth, stain-
less steel, SCHWERT DESIGN, 17,5 cm

1208-345

Seite / Page 109

COOLEY Mikro-Pinzette, gebogen, mit Führungsstift,
rostfrei, SCHWERT DESIGN, 17,5 cm
COOLEY Micro forceps, curved, with guidance pin,
stainless steel, SCHWERT DESIGN, 17,5 cm

1208-355

Seite / Page 109

Mikro-Nahtpinzette gebogen, Ø Ring: 2,0 mm, 17,5 cm
Micro Suture-Forceps, curved, Ø ring: 2,0 mm, 17,5 cm

1705-15

Seite / Page 114

Papillenheber Ø 1,5mm / 2,5mm, auswechselbar, 17,5 cm
Papilla elevator Ø 1,5mm / 2,5mm, exchangeable, 17,5 cm

1705-25

Seite / Page 114

Tunnelier-Instrument OK, Fig. 1, 1,9 / 2,5 mm, 18 cm
Tunneling Knife Upper Jaw, Fig. 1, 1,9 / 2,5 mm, 18 cm

1705-35

Seite / Page 114

Tunnelier-Instrument OK, Fig. 2, 1,9 / 2,5mm, 18 cm
Tunneling Knife Upper Jaw, Fig. 2, 1,9 / 2,5 mm, 18 cm

1705-55

Seite / Page 115

ORBAN Parodontal Messer 1/2, modifiziert, 2,5 mm, 17,5 cm
ORBAN Periodontic knife 1/2, modified, 2,5 mm, 17,5 cm

1705-65

Seite / Page 115

KGF8 Parodontal Messer 1/2, modifiziert, 2,4 mm, 17,5 cm
KGF8 Periodontic knife 1/2, modified, 2,4 mm, 17,5 cm

1705-75

Seite / Page 115

Parodontal Messer Fig. 1, gerade / leicht gebogen,
2,2 mm, 17,5 cm
Periodontic knife Fig. 1, straight / slightly bended,
2,2 mm, 17,5 cm

2000-10

Seite / Page 112

twist TC CASTROVIEJO Mikro Nadelhalter, gerade, mit
Sperre, feines Maul, gerieft, 17,5 cm
twist TC CASTROVIEJO Micro Needle holder, straight,
with lock, delicate bit, serrated, 17,5 cm

2610-1

Seite / Page 234

SCHWERT- Protector 1/1 mit Stegen und Instrumenten-
halter im Deckel 266 x 180 x 36 mm
SCHWERT-Tray with racks and Instrument holder in the lid
266 x 180 x 36 mm



SCHWERT
SWORD · ESPADA
EPEE · SPADA

117

Mikrochirurgie
Microsurgery

2. Mikrochirurgie · Microsurgery

Mikrochirurgie Basis Set · Micro surgical basic kit

i

Mikrochirurgie Basis Set · Micro surgical basic kit

Mit dem Mikrochirurgie Basis Set erhalten Sie ein kostengünstiges hochwertiges Instrumentarium, womit alle mikrochirurgischen Eingriffe durchgeführt werden können.

With the micro surgical basic kit you get a cost saving high quality armamentarium for all micro surgical treatments.

118



1790-230

Mikrochirurgie Basis Set
Micro surgical basic kit

2. Mikrochirurgie · Microsurgery







Mikrochirurgie Basis Set · Micro surgical basic kit



SCHWERT
SWORD · ESPADA
EPEE · SPADA

119

Mikrochirurgie
Microsurgery

	Artikel-Nr. Item-No.	Artikelbeschreibung Description
	<p>1790-230</p>	<p>Mikrochirurgie Basis Set bestehend aus: Micro surgical basic kit consisting of</p>
	<p>1033-1 Seite / Page 54</p>	<p>Skalpellgriffe rund, gerade, 16 cm Scalpel handle round, straight, 16 cm</p>
	<p>1071-15 Seite / Page 106</p>	<p>Halter für Mini-Klingen 15,5 cm Handle for Mini-blades 15,5 cm</p>
	<p>1136-15 Seite / Page 106</p>	<p>Mikro-Scheren, gebogen, 15 cm Micro-surgical scissors, curved, 15 cm</p>
	<p>1208-115 Seite / Page 70</p>	<p>MICRO-ADSON Pinzette 1 x 2 Zähne, 1,0 mm, 15 cm MICRO-ADSON forceps 1x2 teeth, 1,0mm, 15 cm</p>
	<p>1407-24 Seite / Page 77</p>	<p>MOLT Kürette Fig. 2/4, 18 cm MOLT Bone curettes Fig. 2/4, 18 cm</p>
	<p>2002-1 Seite / Page 113</p>	<p>CASTROVIEJO TC Mikro-Nadelhalter, gerade, 14 cm CASTROVIEJO TC micro needle holder, straight, 14 cm</p>
	<p>2599-10 Seite / Page 232</p>	<p>Waschtray für 8 Instrumente mit Silikonauflage und Fixierclip 18 x 13,6 x 2,7 cm Wash - tray for 8 Instruments with silicon rest and fixing clip 18 x 13,6 x 2,7cm</p>

2. Mikrochirurgie · Microsurgery

SCHWERT DESIGN Mikrochirurgie Set · SCHWERT DESIGN Micro surgical kit

i

SCHWERT DESIGN Mikrochirurgie Set SCHWERT DESIGN Micro surgical kit

Mit dem SCHWERT DESIGN Mikrochirurgie Set erhalten Sie ein hochwertiges Instrumentarium im SCHWERT Design, womit alle mikrochirurgischen Eingriffe durchgeführt werden können.

With the SCHWERT DESIGN micro surgical kit you get a high quality armamentarium for all micro surgical treatments.

120

1790-100

SCHWERT DESIGN Mikrochirurgie Set
SCHWERT DESIGN Micro surgical kit

2. Mikrochirurgie · Microsurgery

SCHWERT DESIGN Mikrochirurgie Set · SCHWERT DESIGN Micro surgical kit



SCHWERT
SWORD · ESPADA
EPEE · SPADA

121

Mikrochirurgie
Microsurgery

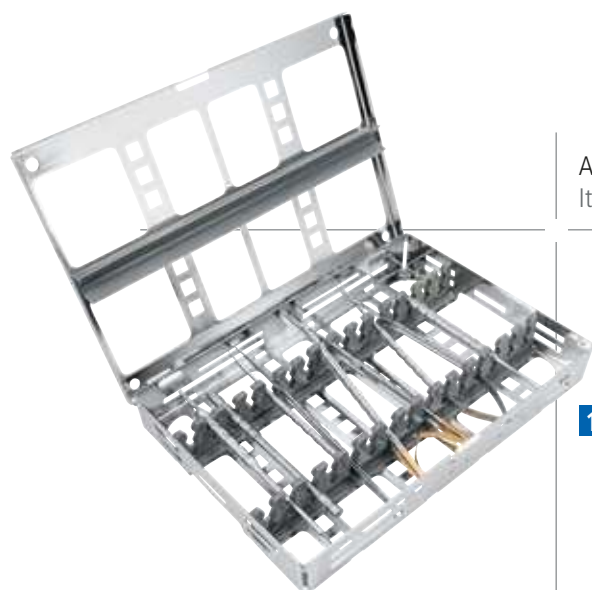

Artikel-Nr.
Item-No.

Artikelbeschreibung
Description

1790-100

SCHWERT DESIGN Mikrochirurgie Set bestehend aus:
SCHWERT DESIGN Micro surgical kit consisting of



1033-50

Seite / Page 53

Skalpellgriff SCHWERT DESIGN, 15 cm
Scalpel handle SCHWERT DESIGN, 15 cm



1070-00

Seite / Page 106

Mikro-Skalpellgriff, Titan, SCHWERT DESIGN, 13 cm
Micro-Scalpel handle, Titanium, SCHWERT DESIGN, 13 cm



1135-17

Seite / Page 107

Mikro-Schere, Mikroverzahnung, spitz/spitz, gebogen,
Ø 8 mm, SCHWERT DESIGN, 17 cm
Micro scissors, micro serrated, pointed/pointed, curved,
Ø 8mm, SCHWERT DESIGN, 17 cm



1208-300

Seite / Page 108

Mikro-Pinzette, gerade mit Führungsstift, 1x2 Zähne,
rostfrei, SCHWERT DESIGN, 17,5 cm
Micro Forceps, straight with guiding pin, 1x2 teeth, stain-
less steel, SCHWERT DESIGN, 17,5 cm



1411-01

Seite / Page 110

Raspatorium 2,6 mm / 4 mm breit, SCHWERT DESIGN
17,5 cm
Periosteal elevator 2,6 mm / 4,0 mm, SCHWERT DESIGN
17,5cm



2000-60

Seite / Page 111

twist TC Mikro Nadelhalter mit Schloss, 17,5 cm
twist TC Micro Needle holder with lock, 17,5 cm

2600-1

Seite / Page 234

SCHWERT- Protector 1/1 mit Stegen, 266 x 180 x 36 mm
SCHWERT-Protector 1/1 with racks, 266 x 180 x 36 mm

2. Mikrochirurgie · Microsurgery

SCHWERT DESIGN Mikrochirurgie Set · SCHWERT DESIGN Micro surgical kit

i

SCHWERT DESIGN Erweitertes Mikrochirurgie Set SCHWERT DESIGN Extended Micro surgical kit

Mit dem erweiterten Mikrochirurgie Set im SCHWERT DESIGN erhalten Sie ein optimal auf alle mikrochirurgischen Eingriffe abgestimmtes Instrumentarium, dass keine Wünsche an Ergonomie und Funktion offen lässt.

With the extended SCHWERT DESIGN Micro surgical kit you get an armamentarium for all micro surgical treatments which leaves nothing to be desired when it comes to ergonomic and functional work.

122

1790-235

SCHWERT DESIGN Erweitertes
Mikrochirurgie Set
SCHWERT DESIGN Extended
Micro surgical kit

2. Mikrochirurgie · Microsurgery

SCHWERT DESIGN Mikrochirurgie Set · SCHWERT DESIGN Micro surgical kit

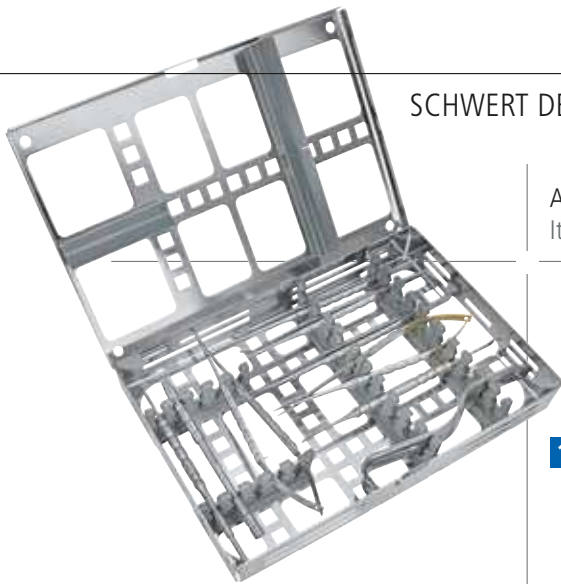

Artikel-Nr.
Item-No.

Artikelbeschreibung
Description

1790-235

SCHWERT DESIGN Erweitertes Mikrochirurgie Set bestehend aus:
SCHWERT DESIGN Extended Micro surgical kit consisting of:



1033-60

Seite / Page 52

SAFE-EX Sicherheitsklingenhalter, zerlegbar, 15 cm
SAFE-EX Safety blade holder, dismantlable, 15 cm



1070-00

Seite / Page 106

Mikro-Scalpellgriff, Titan, SCHWERT DESIGN, 13 cm
Micro-Scalpel handle, Titanium, SCHWERT DESIGN, 13 cm



1136-17

Seite / Page 107

Mikro-Schere, Mikroverzahnung, spitz/spitz, gebogen, Ø 8 mm, SCHWERT DESIGN, 17 cm
Micro scissors, micro serrated, pointed/pointed, curved, Ø 8mm, SCHWERT DESIGN, 17 cm



1208-300

Seite / Page 108

Mikro-Pinzette, gerade mit Führungsstift, 1x2 Zähne, rostfrei, SCHWERT DESIGN, 17,5 cm
Micro Forceps, straight with guiding pin, 1x2 teeth, stainless steel, SCHWERT DESIGN, 17,5 cm



1208-345

Seite / Page 109

COOLEY Mikro-Pinzette, gebogen, mit Führungsstift, rostfrei, SCHWERT DESIGN, 17,5 cm
COOLEY Micro forceps, curved, with guidance pin, stainless steel, SCHWERT DESIGN, 17,5 cm



1208-355

Seite / Page 109

Mikro-Nahtpinzette gebogen, Ø Ring: 2,0 mm, SCHWERT Design, 17,5 cm
Micro Suture-Forceps, curved, Ø ring: 2,0 mm, SCHWERT DESIGN, 17,5 cm



1411-01

Seite / Page 110

Raspatorium 2,6 mm / 4 mm breit, SCHWERT DESIGN 17,5 cm
Periosteal elevator 2,6 mm / 4,0 mm, SCHWERT DESIGN 17,5 cm



2000-10

Seite / Page 112

twist TC CASTROVIEJO Mikro Nadelhalter, gerade, mit Sperre, feines Maul, gerieft, 17,5 cm
twist TC CASTROVIEJO Micro Needle holder, straight, with lock, delicate bit, serrated, 17,5 cm



2460

Seite / Page 87

MINNESOTA Zungen- und Wangenabhalter, 16 cm
MINNESOTA Tongue/cheek retractor, 16 cm

2610-1

Seite / Page 234

SCHWERT- Protector 1/1 mit Stegen und Instrumentenhalter im Deckel 266 x 180 x 36 mm
SCHWERT-Tray with racks and Instrument holder in the lid 266 x 180 x 36 mm



SCHWERT
SWORD · ESPADA
EPEE · SPADA

123

Mikrochirurgie
Microsurgery



2. Mikrochirurgie · Microsurgery

Grid of dots for product listing

SCHWERT
SWORD · ESPADA
EPEE · SPADA

124