

Flachmeißel

Chisels
Cinceles
Ciseaux burins
Scalpelli

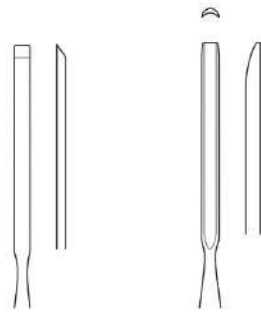

23-060-20-07 23-061-20-07



23-105-02-07 23-106-02-07
13,5 cm / 5 3/8" 17 cm / 6 5/8"
2 mm 2 mm



5 mm

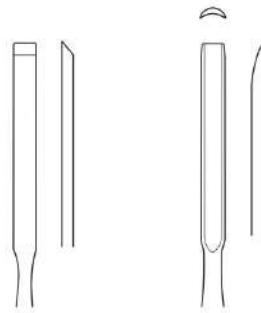

23-060-30-07 23-061-30-07



23-105-03-07 23-106-03-07
13,5 cm / 5 3/8" 17 cm / 6 5/8"
3 mm 3 mm



23-105-04-07 23-106-04-07
13,5 cm / 5 3/8" 17 cm / 6 5/8"
4 mm 4 mm



Iglhaut
38-800-05-07
17 cm / 6 5/8"



Buckley
23-060-20-07 -
23-061-40-07
16 cm / 6 2/8"

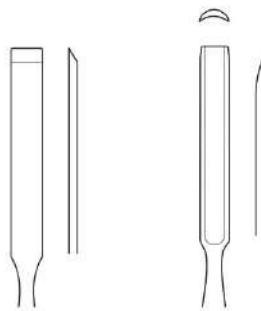

23-060-40-07 23-061-40-07



23-105-05-07 23-106-05-07
13,5 cm / 5 3/8" 17 cm / 6 5/8"
5 mm 5 mm



23-105-06-07 23-106-06-07
13,5 cm / 5 3/8" 17 cm / 6 5/8"
6 mm 6 mm



Partsch
23-105-02-07 -
23-106-06-07

Hohlmeißel, Osteotome

Gouges, osteotomes
Gubias, osteótomos
Gouges, ostéotomes
Sgorbie, osteotomi

Meißel, Raspatorien

Chisels, periosteal elevators
Cinceles, periostótomos
Ciseaux burins, raspatoires
Scalpell, periostotomi

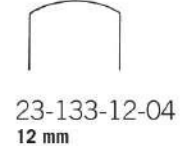
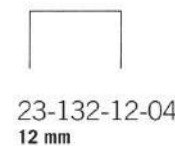
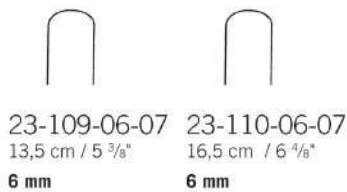
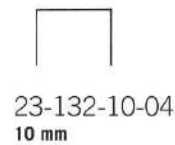
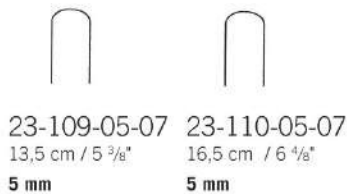
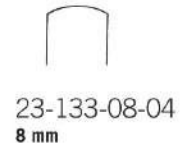
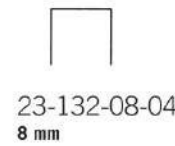
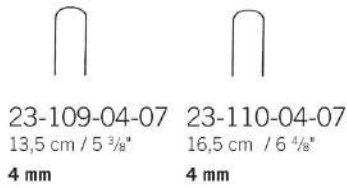
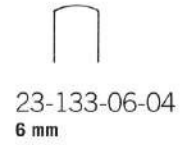
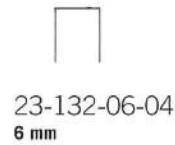
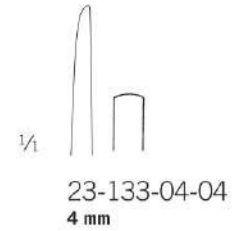
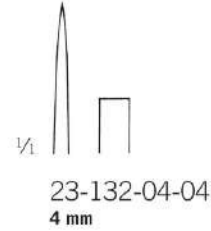
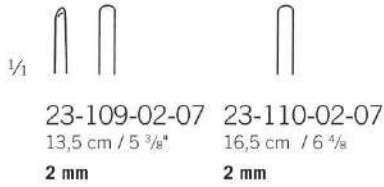

Partsch
23-109-02-07 -
23-110-06-07



Lexer-Mini
23-132-04-04 -
23-132-12-04
18 cm / 7 1/8"



auch erhältlich mit Ferrozell-Handgriff
also available with Ferrozell handle
también disponible con mango Ferrozell
disponible avec manche Ferrozell
disponibile con manico Ferrozell



Lexer-Mini
23-133-04-04 -
23-133-12-04
18 cm / 7 1/8"



auch erhältlich mit Ferrozell-Handgriff
also available with Ferrozell handle
también disponible con mango Ferrozell
disponible avec manche Ferrozell
disponibile con manico Ferrozell

Osteotome

Osteotomes

Osteótomos

Ostéotomes

Osteotomi

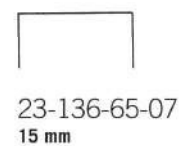
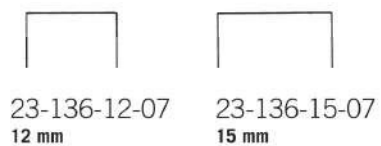
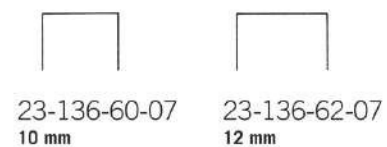
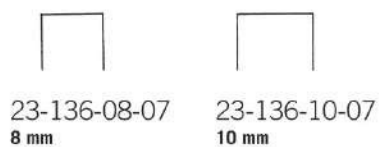
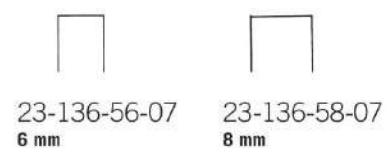
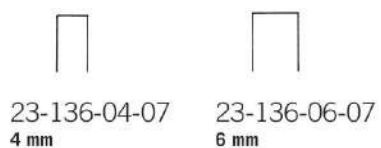

Lambotte-Mini
23-136-02-07 -
23-136-15-07
12,5 cm / 4 $\frac{7}{8}$ "



Lambotte-Mini
23-136-53-07 -
23-136-65-07
17 cm / 6 $\frac{6}{8}$ "

Stößel

Tampers
Punzones metálicos
Pilons métalliques
Pestoni metallici

Meißel, Raspatorien

Chisels, periosteal elevators
Cinceles, periostótomos
Ciseaux burins, raspatoires
Scalpell, periostotomi

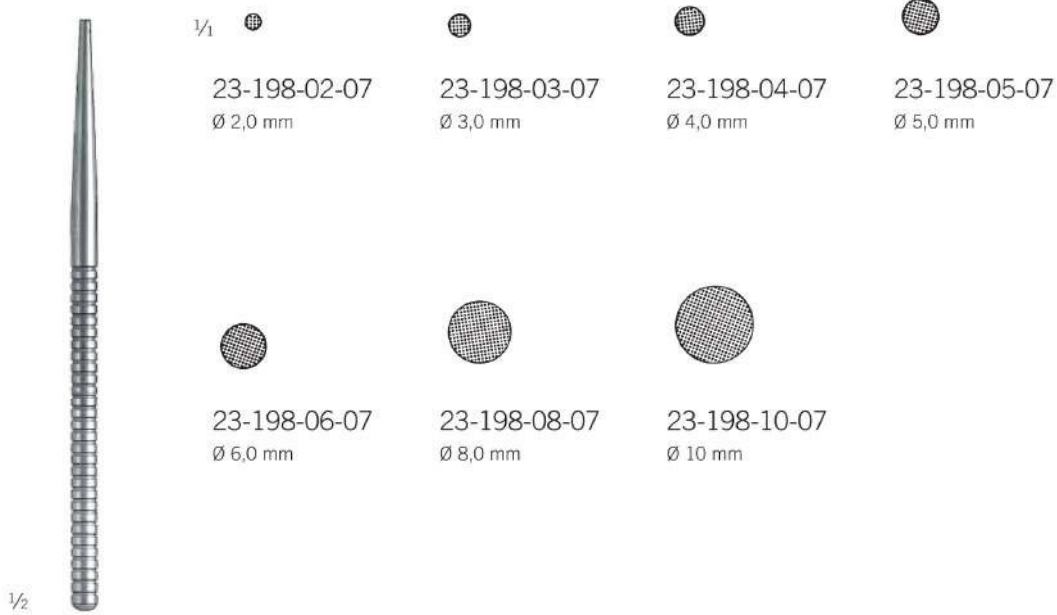

23-198-02-07 -
23-198-10-07
15,5 cm / 6 1/8"

Hämmer

Mallets

Martillos

Maillets

Martelli



1/2

Williger
23-216-01-07
16,5 cm / 6 4/8"

Kopf	Gewicht
head	weight
cabeza	peso
tête	poids
testa	peso
Ø 20 mm	140 g



1/2

Herbert
23-264-19-04
19 cm / 7 4/8"

für Ulnakopfprothesen
for ulna head prosthesis
para prótesis de la cabeza ulnar
pour prothèse de la tête ulna
protesi per la testa ulnare

Kopf	Kopf
head	head
cabeza	cabeza
tête	tête
testa	testa
Ø 25 mm	215 g



auch erhältlich mit Ferrozell-Handgriff
also available with Ferrozell handle
también disponible con mango Ferrozell
disponible avec manche Ferrozell
disponibile con manico Ferrozell

Scharfe Löffel

Bone curettes
Cucharillas cortantes
Curettes tranchantes
Curette taglienti

Meißel, Raspatorien

Chisels, periosteal elevators
Cinceles, periostótomos
Ciseaux burins, raspatoires
Scalpelli, periostotomi



Fig. 0
23-280-10-04



Fig. 00
23-280-20-04



Fig. 000
23-280-30-04



Fig. 0000
23-280-40-04



1/2

Volkmann
23-280-10-04 -
23-280-40-04

17 cm / 6 5/8"

oval
oval
ovalada
ovale
ovala

Sic

auch erhältlich mit Ferrozell-Handgriff
also available with Ferrozell handle
también disponible con mango Ferrozell
disponible avec manche Ferrozell
disponibile con manico Ferrozell



Fig. 0
23-304-10-07



Fig. 00
23-304-20-07



Fig. 000
23-304-30-07



Fig. 0000
23-304-40-07



1/2

Volkmann
23-304-10-07 -
23-304-40-07

17 cm / 6 5/8"

oval, mit Hohlheft
oval, with hollow handle
ovalada, con mango hueco
ovale, avec manche creux
ovala, con manico vuoto



Fig. 00
23-308-10-07



Fig. 00
23-308-20-07



Fig. 000
23-308-30-07



Fig. 0000
23-308-40-07



1/2

Bruns
23-308-10-07 -
23-308-40-07

17 cm / 6 5/8"

rund, mit Hohlheft
round, with hollow handle
redonda, con mango hueco
rond, avec manche creux
rotonda, con manico vuoto

Scharfe Doppellöffel, Periotome

Bone cures, double ended, periotomes

Cucharillas de doble extremo, periótomos

Curettes doubles, periotomes

Curette doppie, periotomi

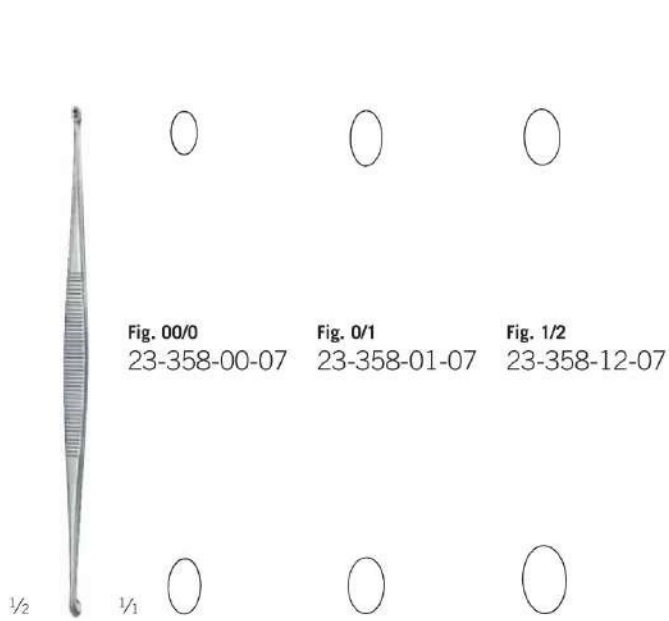

Fig. 00/0
23-358-00-07

Fig. 0/1
23-358-01-07

Fig. 1/2
23-358-12-07

Williger
23-358-00-07 -
23-358-12-07
14 cm / 5 5/8"

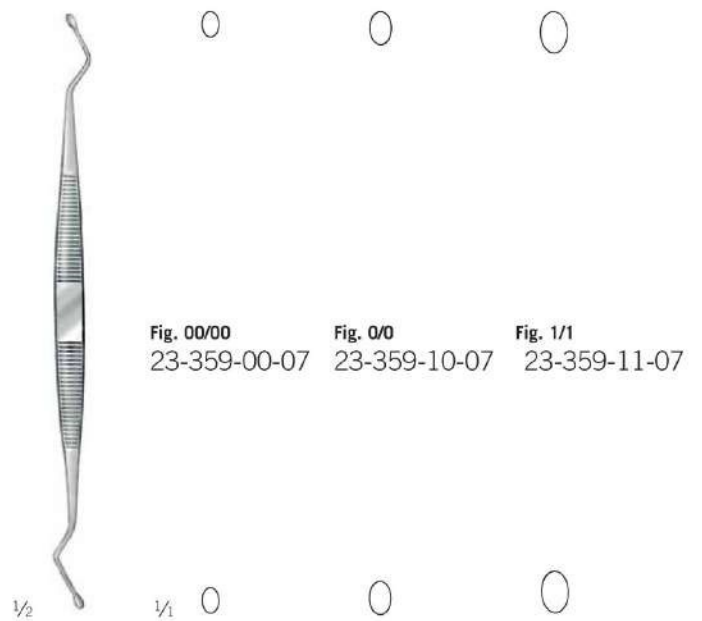
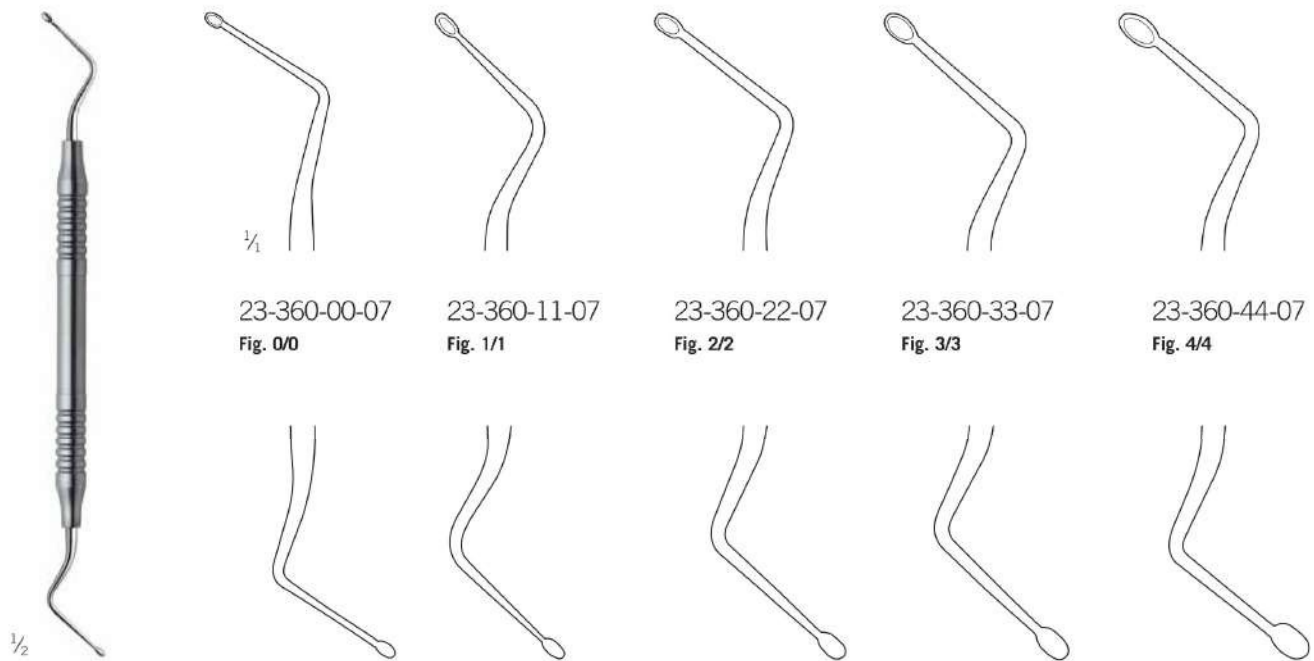

Fig. 00/00
23-359-00-07

Fig. 0/0
23-359-10-07

Fig. 1/1
23-359-11-07

Williger
23-359-00-07 -
23-359-11-07
16,5 cm / 6 5/8"



23-360-00-07
Fig. 0/0

23-360-11-07
Fig. 1/1

23-360-22-07
Fig. 2/2

23-360-33-07
Fig. 3/3

23-360-44-07
Fig. 4/4

Hemingway
23-360-00-07 -
23-360-44-07
17 cm / 6 5/8"

Periotome

Periotomes
Pperiótomos
Periotomes
Periotomi

Meißel, Raspatorien

Chisels, periosteal elevators
Cinceles, periostótomos
Ciseaux burins, raspatoires
Scalpelli, periostotomi

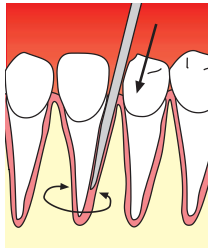
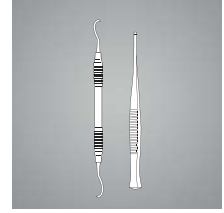

23-360-01-07

14 cm / 5 1/2"

Griff für Periotom-Ansätze
Handle for periotome tips
mango para periótomos
manche de pointes de périotomes
manico de periotomi

verdrehssicher
anti rotation
a prueba de torsión
antitorsion
antitorsione



23-360-02-07

gerade, schmal
straight, narrow
recta, estrecha
droit, étroit
diritto, sottile
No. 1



23-360-03-07

gerade, breit
straight, wide
recta, ancha
droit, large
diritto, largo
No. 2



23-360-04-07

gebogen, schmal
curved, narrow
curva, estrecha
courbé, étroit
arcuato, sottile
No. 1A



23-360-05-07

gebogen, breit
curved, wide
curva, ancha
courbé, large
arcuato, largo
No. 2A



23-360-06-07

abgewinkelt, schmal
angled, narrow
acodada, estrecha
coudé, étroit
angolato, sottile
No. 1B



23-360-07-07

abgewinkelt, breit
angled, wide
acodada, ancha
coudé, large
angolato, largo
No. 2B



Chirurgische Küretten

Bone curettes, double ended

Cucharillas de doble extremo

Curettes doubles

Curette doppie



23-362-00-07
Fig. 0/0



23-362-11-07
Fig. 1/1



23-362-22-07
Fig. 2/2



23-362-33-07
Fig. 3/3

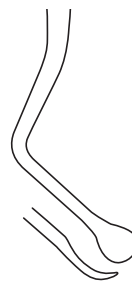
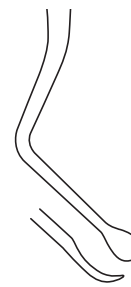
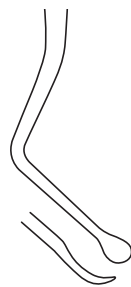
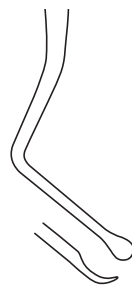

Lucas-Martin
23-362-00-07 -
23-362-33-07
17,5 cm / 6 7/8"

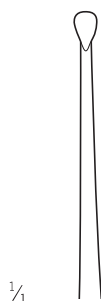

23-364-00-07
Fig. 0



23-364-01-07
Fig. 1

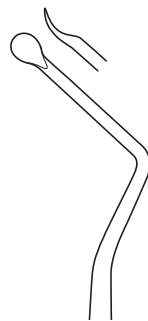

23-364-02-07
Fig. 2



23-364-03-07
Fig. 3



23-364-04-07
Fig. 4

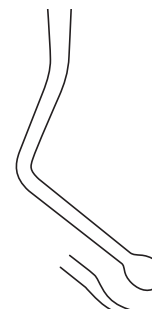
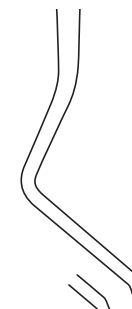

Miller-Colburn
23-364-00-07 -
23-364-04-07
19 cm / 7 4/8"

Scharfe Küretten, Chirurgische Küretten

Bone curettes, bone curettes, double ended
 Curetas cortantes, cucharillas de doble extremo
 Curettes, curettes doubles
 Curette, curette doppia

Meißel, Raspatorien

Chisels, periosteal elevators
 Cinceles, periostótomos
 Ciseaux burins, raspatoires
 Scalpelli, periostotomi

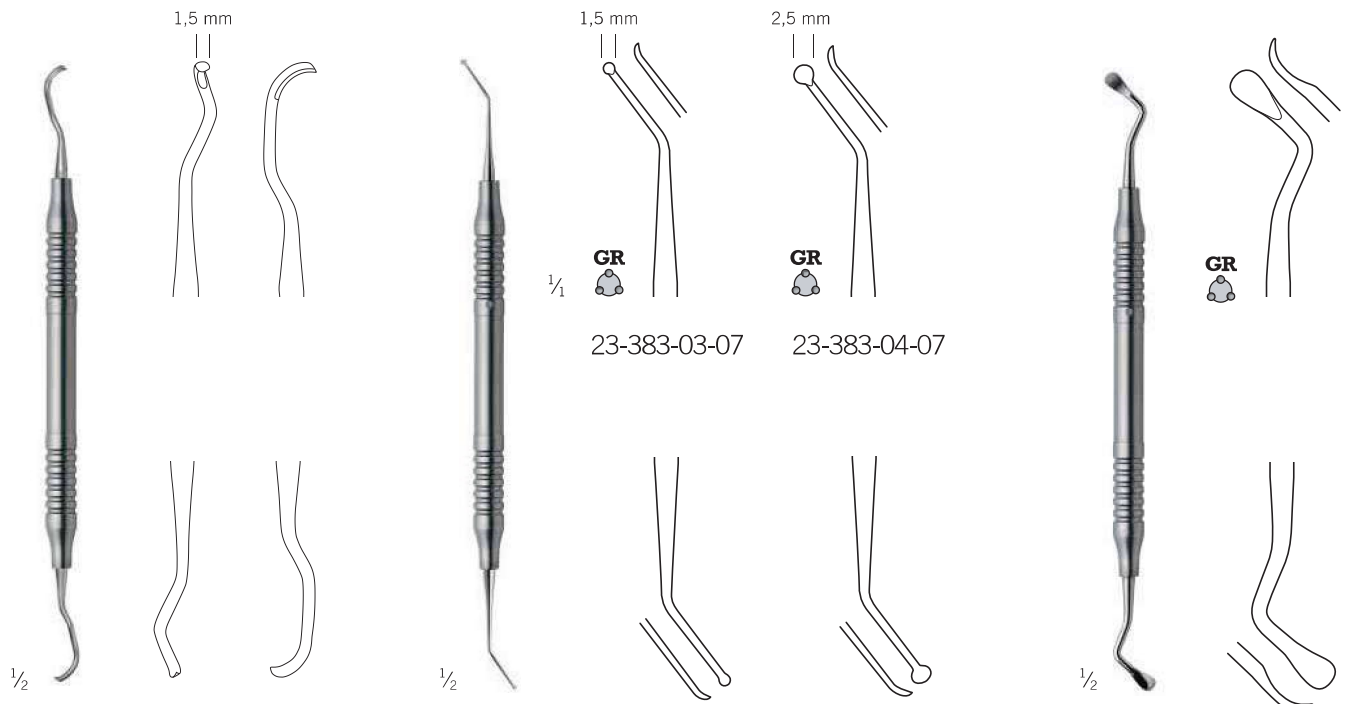
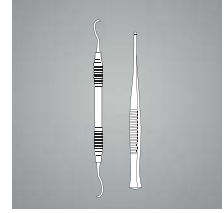

Iglhaut
 23-320-01-07
 17 cm / 6 ³/₄"

Knochenkürette
 Bone curette
 Cucharilla p. ósea
 Curette pour os
 Curetta per osso

23-383-03-07 -
 23-383-04-07
 17 cm / 6 ⁶/₈"

Tellerkürette
 Plate type curette
 Cureta tipo plato
 Curette circulaire
 Curetta di tipo piatto

23-395-21-07
 17,5 cm / 6 ⁷/₈"

- | | | | | | | | |
|--|--|---|--|--|---|--|--|
| GR = grau
grey
gris
gris
grigio | Y = gelb
yellow
amarillo
jaune
giallo | R = rot
red
rojo
rouge
rosso | G = grün
green
verde
vert
verde | V = violett
violet
violeta
violet
viola | W = weiß
white
blanco
blanc
bianco | B = blau
blue
azur
bleu
blu | N = schwarz
black
negro
noir
nero |
|--|--|---|--|--|---|--|--|

Raspatorien

Periosteal elevators
 Periostótomos, legras
 Rugines raspatoires, rugines
 Periostotomi



Kahre-Williger
 23-436-04-07 -
 23-436-05-07
 16,5 cm / 6 1/8"
 massiv
 solid
 macizo
 solide
 pieno

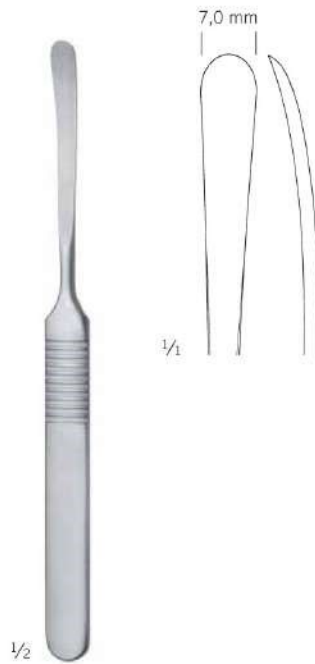

Williger
 23-436-07-07
 16 cm / 6 1/8"
 massiv
 solid
 macizo
 solide
 pieno

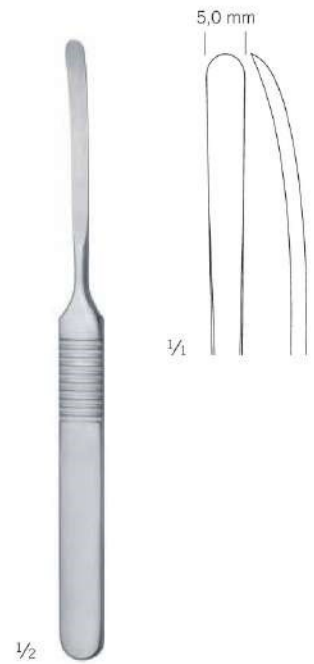

Williger
 23-436-16-07
 16 cm / 6 1/8"
 massiv
 solid
 macizo
 solide
 pieno



23-435-17-07 -
 23-435-19-07
 17 cm / 6 5/8"
 Mikro-Abhalter
 Micro retractor
 Micro separador
 Micro rétracteur
 Micro divaricatore

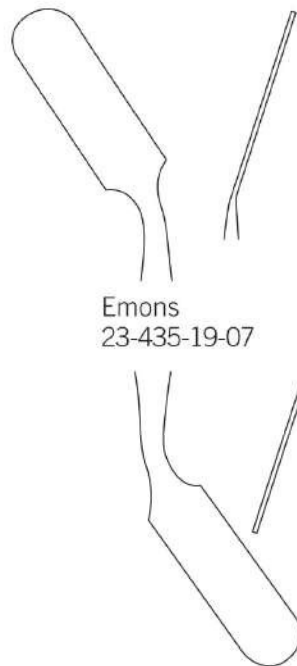

Emons
 23-435-19-07

Meißel, Raspatorien

Chisels, periosteal elevators

Cinceles, periostótomos

Ciseaux burins, raspatoires

Scalpelli, periostotomi

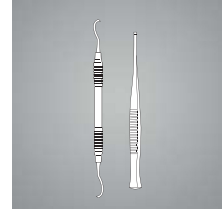

1/2

23-436-22-07 -
23-436-23-07

17,5 cm / 6 7/8"

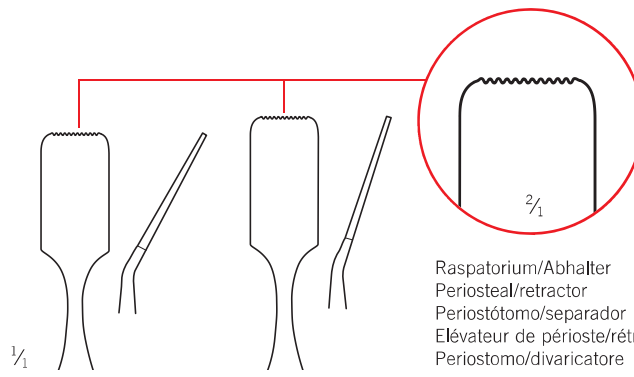

1/1

23-436-22-07

23-436-23-07

Raspatorium/Abhalter
Periosteal/retractor
Periostótomoseparador
Élévateur de périoste/rétracteur
Periostomo/divaricatore

Abhalter, rutschsicher, gezahnt
Retractor, serrated, anti slip
Separador, dentado, antideslizable
Écarteur, denté, antiglissant
Divaricatore, antiscivolo, dentato

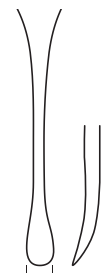

3,0 mm



4,0 mm

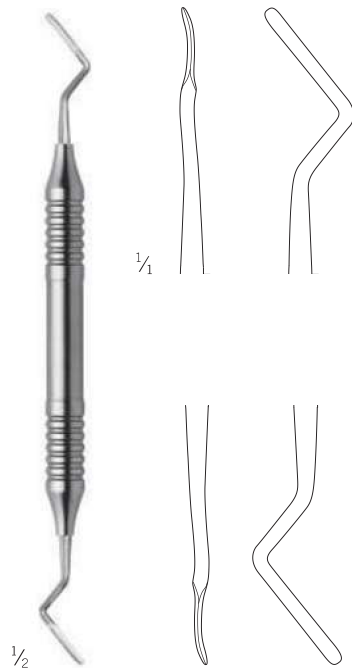

1/1

1/2

Iglhaut
38-050-02-07

18 cm / 7 1/8"

Tunnelinstrument
Tunnelinstrument
Instrument p. tunnel
Instrumento p. traforo

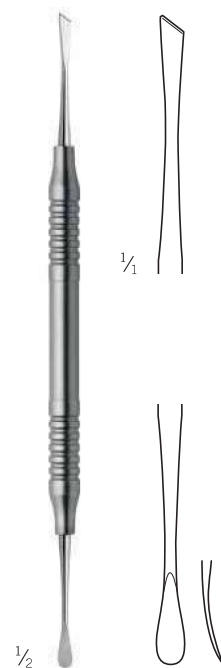

1/1

1/2

West
23-446-18-07

18 cm / 7 1/8"

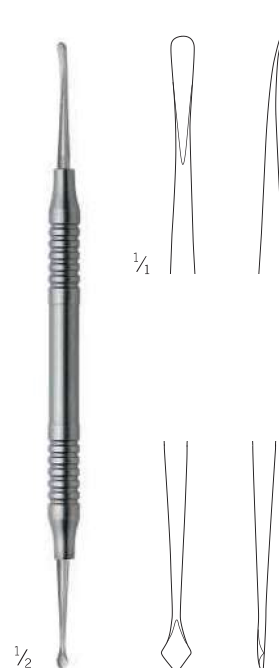

1/1

1/2

Iglhaut
23-402-18-07

18 cm / 7 1/8"

Micro-Raspatorium
Periosteal elevator
Periostotomo
Raspatoire
Scollatore

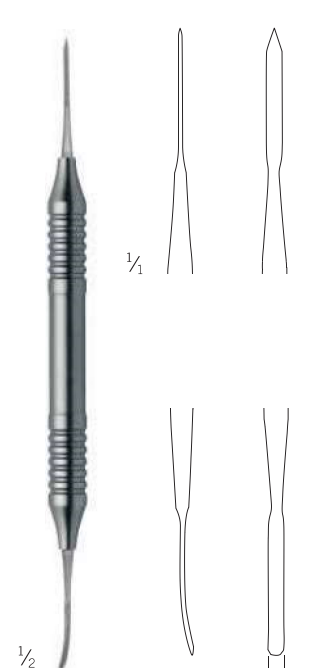

1/1

1/2

Allen-Iglhaut
38-050-01-07

18 cm / 7 1/8"

Raspatorium
Periosteal elevator
Periostotomo
Raspatoire
Scollatore

2,0 mm

Raspatorien

Periosteal elevators
 Periostótomos, legras
 Rugines raspatoires, rugines
 Periostotomi



Körner/Westermann

23-448-01-09 -

23-448-02-07

18 cm / 7 1/8"

Mini-Dissektor / Gewebepusher
 zur atraumatischen Aktivierung der Interdentalpapille

Mini dissector / tissue pusher
 for atraumatic activation of interdental papilla

Mini disector / separador de tejido
 para la activación atraumática de la papila interdental

Instrument de dissection mini / séparateur de tissu
 pour l'activation atraumatique de la papille interdentaire

Strumento per dissezione mini / separatore di tessuto
 per l'attivazione atraumatica della papilla interdental



23-448-01-09

Ti



23-448-02-07

St



Raspatorium 2 mm breit
 Periosteal elevator 2 mm wide
 Periostótomos, ancho 2 mm
 Raspatoire 2 mm de large
 Periostotomo larghezza 2 mm

Gewebepusher Ø 1,1 mm
 Tissue pusher Ø 1.1 mm
 Separador de tejido Ø 1,1 mm
 Écarteur de tissu Ø 1,1 mm
 Separatore di tessuto Ø 1.1 mm

Raspatorium 2 mm breit
 Periosteal elevator 2 mm wide
 Periostótomos, ancho 2 mm
 Raspatoire 2 mm de large
 Periostotomo larghezza 2 mm

Gewebepusher Ø 1,1 mm
 Tissue pusher Ø 1.1 mm
 Separador de tejido Ø 1,1 mm
 Écarteur de tissu Ø 1,1 mm
 Separatore di tessuto Ø 1.1 mm

Meißel, Raspatorien

Chisels, periosteal elevators

Cinceles, periostótomos

Ciseaux burins, raspatoires

Scalpelli, periostotomi

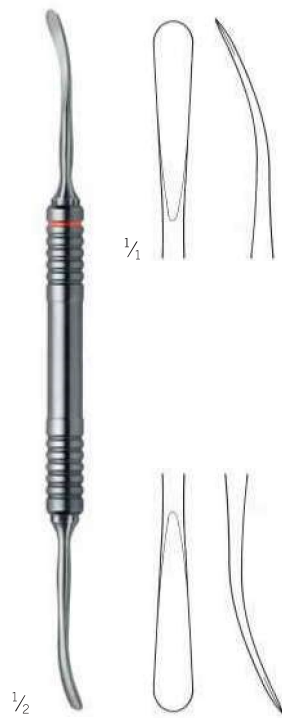
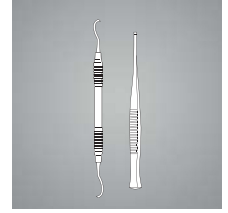

Freer
23-400-18-07
18,5 cm / 7 1/4"

Septumeelevator / Dentalhandgriff Dr. Wörtche
Septum elevator / Handle Dr. Wörtche
Elevador / Mango Dr. Wörtche
Elevateur / Manche Dr. Wörtche
Elevatore / Manico Dr. Wörtche



23-448-11-07

Körner/Westermann
23-448-11-07

16,5 cm / 6 4/8"

Raspatorium / Spiegelaufnahme
zur Gewebeaktivierung und palatinaler Sichtkontrolle

Periosteal / mirror end
for tissue activation and palatine visual control

Periostótomo / extremo para espejo
para la activación del tejido y el control visual del palatino

Elévateur de périoste / extrémité de miroir
pour l'activation des tissus et le contrôle visuel du palais

Periostotomo / estremità a specchio
per l'attivazione del tessuto e l'ispezione visiva del palatino

Raspatorien

Periosteal elevators
Periostótomos, legras
Rugines raspatoires, rugines
Periostotomi

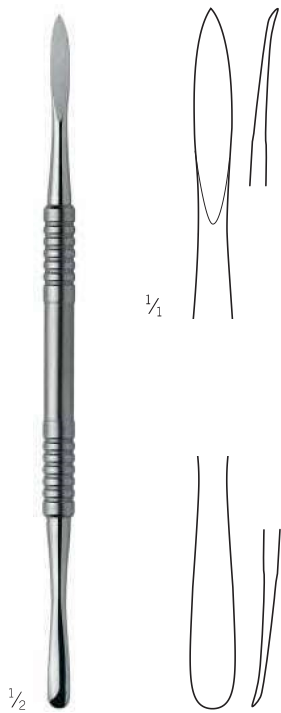

Ohl
23-449-18-07
17,5 cm / 6 $\frac{7}{8}$ "

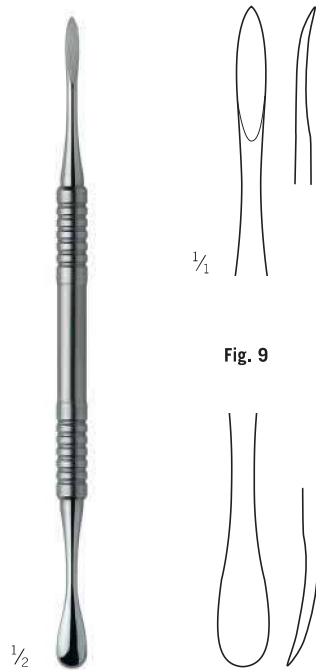

Molt
23-452-09-07
18 cm / 7 $\frac{1}{8}$ "

Fig. 9

Meißel, Raspatorien

Chisels, periosteal elevators

Cinceles, periostótomos

Ciseaux burins, raspatoires

Scalpelli, periostotomi

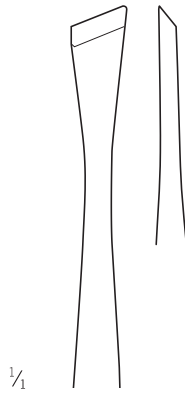
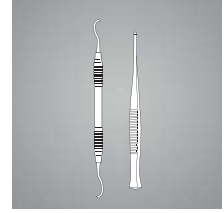
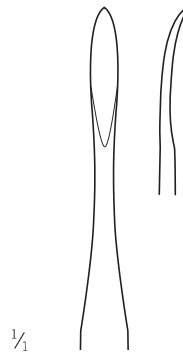

Fig. 851
23-452-51-07
18 cm / 7 1/8"



Fig. 854
23-452-54-07
17 cm / 6 3/4"



Alijberg
23-454-19-07
18 cm / 7 1/8"



Alley
23-454-20-07
20 cm / 7 7/8"



Molt
23-452-51-07 -
23-452-54-07



23-454-19-07 -
23-454-20-07

Knochenfeilen

Bone files
Limas para huesos
Limes à os
Lime per ossa



Fig. 1
23-490-01-07

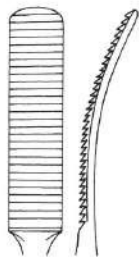

Fig. 2
23-490-02-07

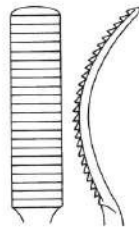

Fig. 3
23-490-03-07

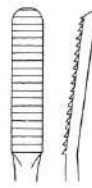
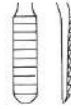
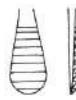
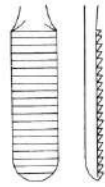

Fig. 4
23-490-04-07



Fig. 5
23-490-05-07



Miller-Colburn
23-490-01-07 - 23-490-05-07

18 cm / 7 1/8"

auf Zug schneidend
downwards cutting
corte abajo
tranchant en bas
tagliente in basso

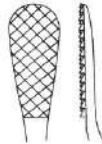

Fig. 1
23-491-01-07

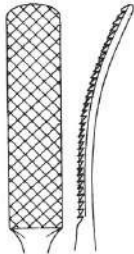

Fig. 2
23-491-02-07

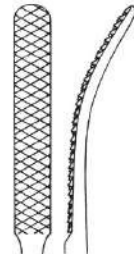

Fig. 3
23-491-03-07

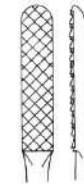
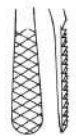
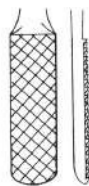
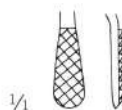

Fig. 4
23-491-04-07



Miller-Colburn
23-491-01-07 - 23-491-04-07

18 cm / 7 1/8"

Kreuzhieb
cross cut
picado en cruz
taille croisée
tagliente a croce

Alveotomiefeilen, Elevatorien, Raspatorien

Alveotomy files, elevators, periosteal elevators

Limas para alveolotomía, elevadores, periostótomos

Limes pour alvéolotomie, élévateurs, rugines raspatoires

Lime per alveolotomia, elevatori, periostotomi

Meißel, Raspatorien

Chisels, periosteal elevators

Cinceles, periostótomos

Ciseaux burins, raspatoires

Scalpelli, periostotomi

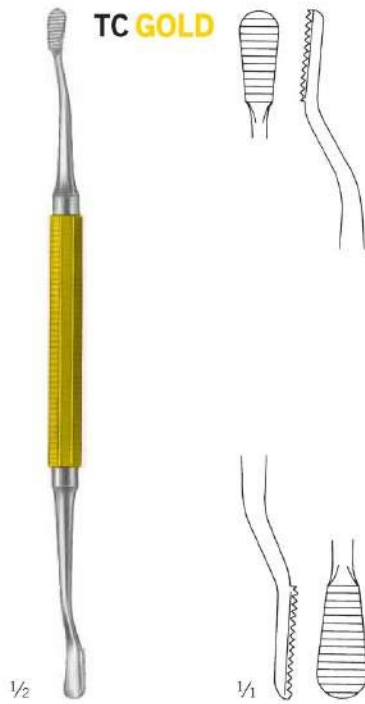

Miller
23-492-01-07
19 cm / 7 1/2"

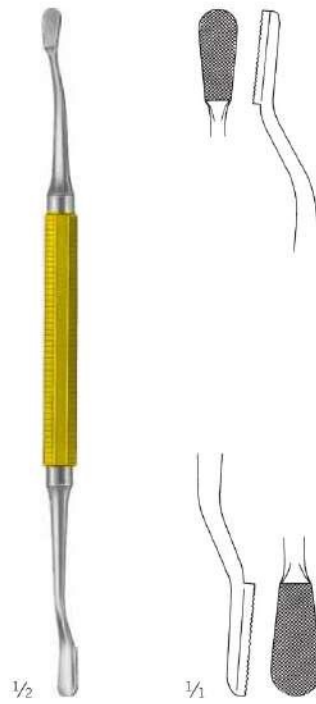

Miller
23-493-01-07
19 cm / 7 1/2"

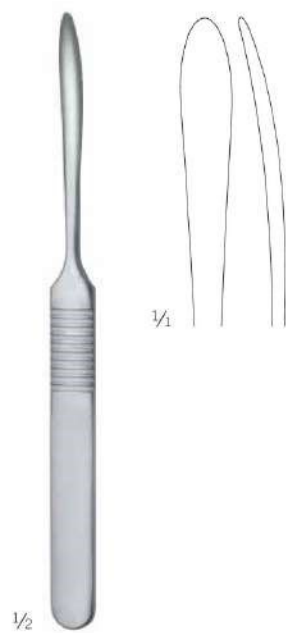

Williger
23-510-17-07
17 cm / 6 5/8"

massiv
solid
macizo
solide
pieno
7 mm

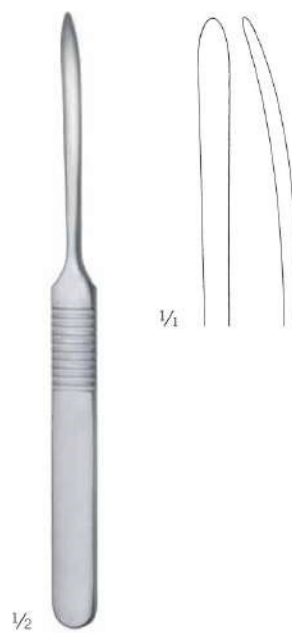

Williger
23-513-16-07
16 cm / 6 1/8"

massiv
solid
macizo
solide
pieno
4 mm

Hohlmeißelzangen

Bone rongeurs

Pinzas gubias

Pinces gouges

Pinze sgorbie

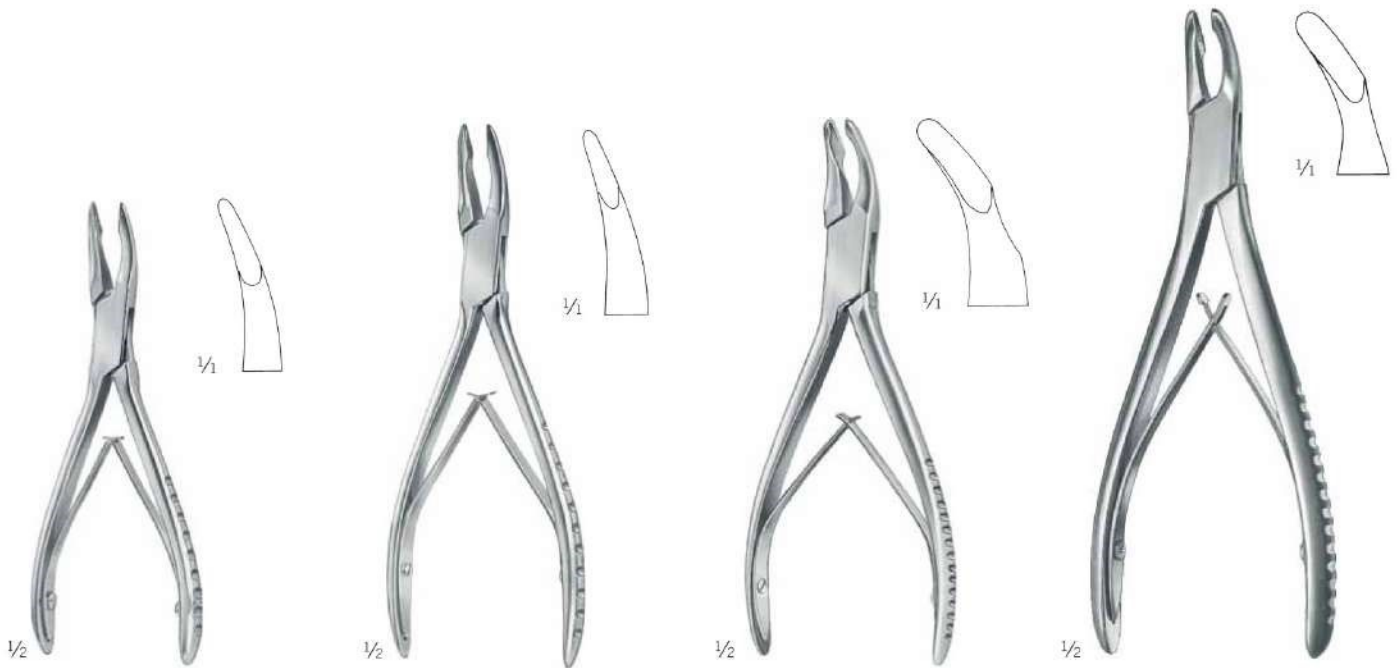

Friedmann
23-799-12-07
12,5 cm / 4 7/8"

Friedmann
23-801-14-07
13,5 cm / 5 3/8"

Cleveland
23-805-14-07
13,5 cm / 5 3/8"

Cleveland
23-807-17-07
16,5 cm / 6 4/8"

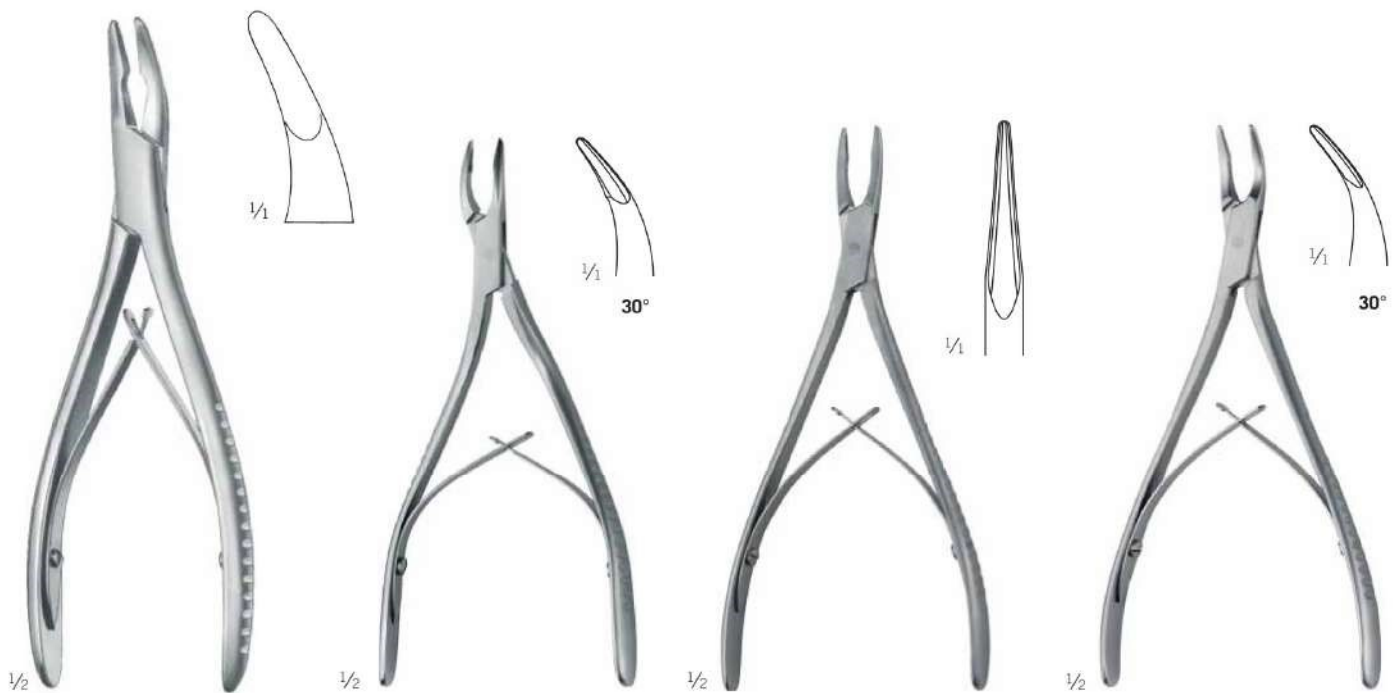

Hartmann
23-819-18-07
17,5 cm / 6 7/8"

23-835-30-07
14,5 cm / 5 6/8"
S-Form
S-shape
forma S
courbé en S
curvo in forma S

23-836-00-07
15,5 cm / 6 1/8"

23-836-30-07
15,5 cm / 6 1/8"

Meißel, Raspatorien

Chisels, periosteal elevators

Cinceles, periostótomos

Ciseaux burins, raspatoires

Scalpelli, periostotomi



23-836-90-07
14,5 cm / 5 7/8"

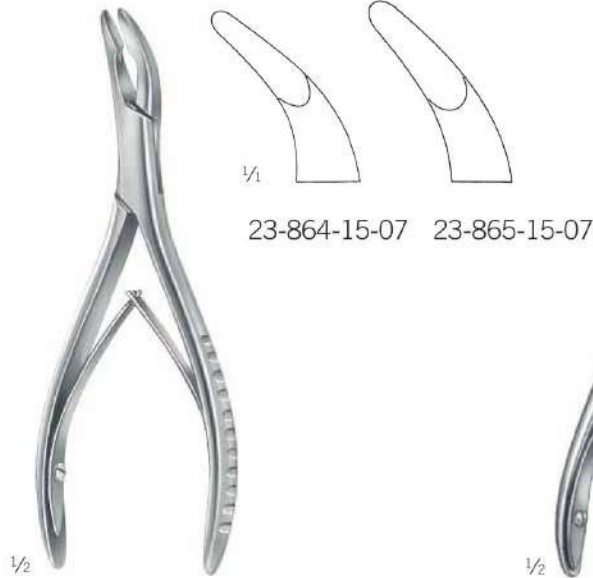

Luer
23-864-15-07 - 23-865-15-07
14,5 cm / 5 7/8"



Böhler
23-876-15-07 - 23-877-15-07
15 cm / 5 7/8"



Beyer
23-879-18-07
18 cm / 7 1/8"



Mayfield
23-883-17-07
18 cm / 7 1/8"



Ruskin
23-887-18-07
19 cm / 7 4/8"

23

Knochensplitterzangen

Bone cutting forceps

Pinzas cortantes para hueso

Pinces coupantes à os

Cesoie per ossa

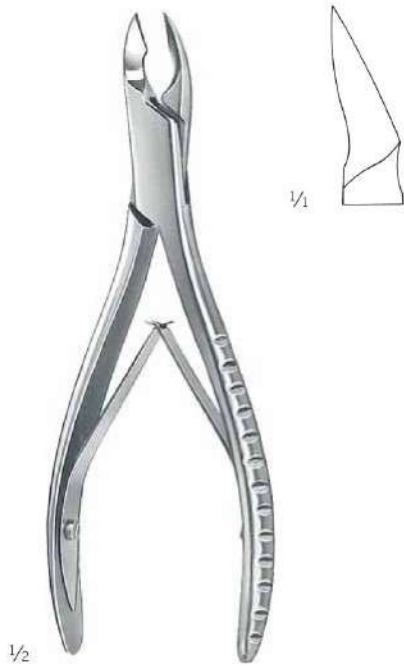

Cleveland
23-939-17-07
17 cm / 6 5/8"



Cleveland
23-941-15-07
14,5 cm / 5 5/8"

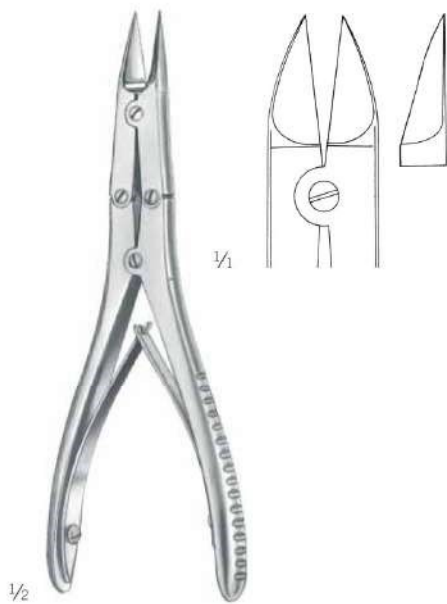

Böhler
23-944-15-07
14,5 cm / 5 5/8"



Böhler
23-946-15-07
14,5 cm / 5 5/8"

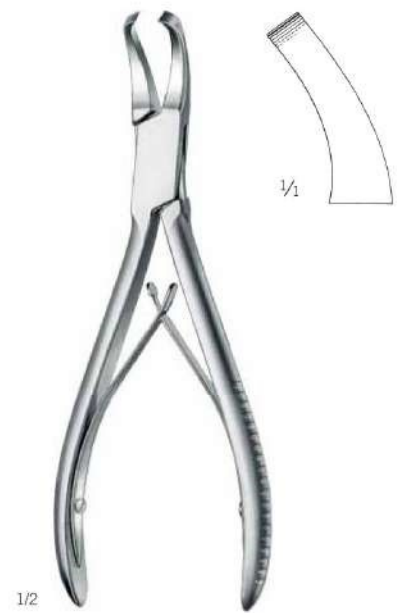

Cleveland
23-947-16-07
17 cm / 6 5/8"

Elevatorien

Elevators
Elevadores
E|évateurs
Elevatori

Meißel, Raspatorien

Chisels, periosteal elevators
Cinceles, periostótomos
Ciseaux burins, raspatoires
Scalpelli, periostotomi

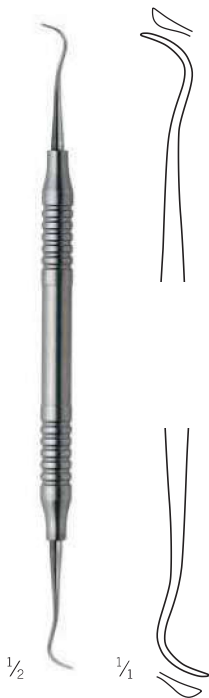
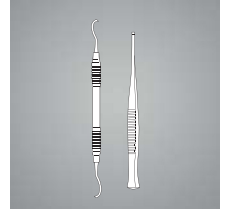

Akiyama
23-406-18-07
18 cm / 7 1/8"

Mikro-Elevator papille
Micro elevator papilla
Micro elevador de la papila
Micro elevateur de la papille
Micro elevatore della papilla



Akiyama
23-407-18-07
18 cm / 7 1/8"

Mikro-Elevator perio
Micro elevator perio
Micro-elevador perio
Micro-elevateur perio
Micro-elevatore perio

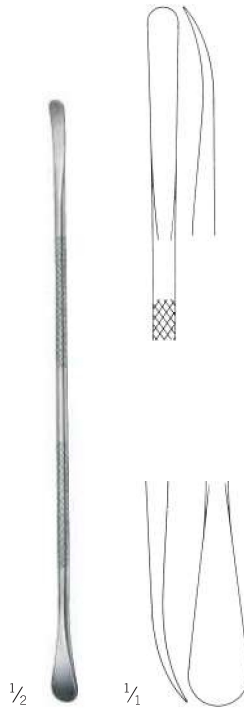

Terry
38-011-16-07
17 cm / 6 5/8"

zur Alveolarlappenabhebung
for elevation of alveolar flaps
para la elevación de las aletas alveolares
pour élévation du lambeau alvéolaire
per la elevazione del lembo alveolare



Terry
38-014-00-07
18 cm / 7 1/8"

für subperiostale Tunnel
for subperiosteal tunnels
para túneles subperiósticos
pour tunnel subpériostal
per tunnel supperiostale

Meißel, Raspatorien

Chisels, periosteal elevators

Cinceles, periostótomos

Burins, élévateurs du périoste

Scalpelli, leve periostali

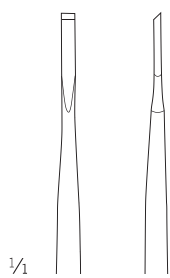

43-700-01-07

Fig. 1



43-700-02-07

Fig. 2

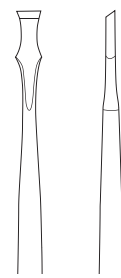

43-700-03-07

Fig. 3

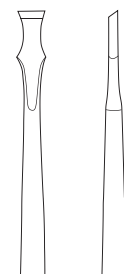

43-700-04-07

Fig. 4



1/2

Iglhaut

43-700-01-07 -

43-700-04-07

18 cm / 7 1/8"

für ziehende Bewegungen „Back Action“

for pull application “Back Action”

para movimientos extractores “Back Action”

pour mouvements de traction «Back Action»

per movimenti di trazione “Back Action”

Elevatorium, Raspatorium

Elevator, raspatory
Elevador, legra
Élévateur, rugine raspatoire
Elevatore, elevatore periostale

Meißel, Raspatorien

Chisels, periosteal elevators
Cinceles, periostótomos
Ciseaux burins, raspatoires
Scalpelli, periostotomi

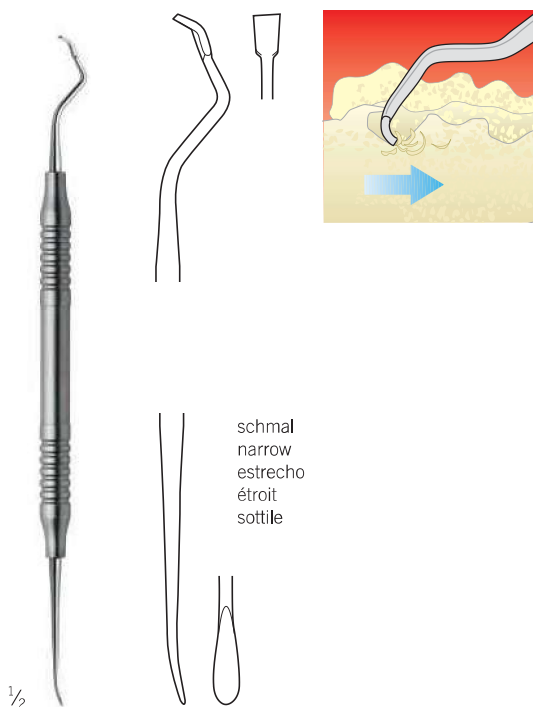
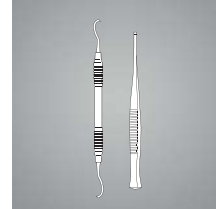

43-883-16-07

für ziehende Bewegungen „Back Action“
for pull application “Back Action”
para movimientos extractores “Back Action”
pour mouvements de traction «Back Action»
per movimenti di trazione “Back Action”

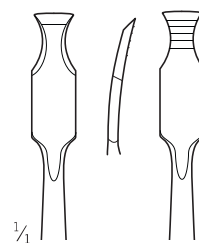

43-884-03-07

Fig. 1

modifiziert
modified
modificada
modifiée
modificata

aufwärts gebogen
upwards curved
curvos hacia arriba
courbé vers le haut
curvo verso l'alto

Rückseite graduiert
back side graduation
parte de atrás graduada
face arrière graduée
lato posteriore graduato

1/2

Ochsenbein
43-884-03-07

Zur Entnahme von Transplantaten und Spongiosa
for removing transplants and spongiosa
para extraer trasplantes y la sustancia esponjosa
pour prélever des transplants et du tissu spongieux
per la rimozione dei trapianti e della materia spongiosa



43-885-03-07

Fig. 2

modifiziert
modified
modificada
modifiée
modificata

abwärts gebogen
downwards curved
curvos hacia abajo
courbé vers le bas
curvo verso il basso

Rückseite graduiert
back side graduation
parte de atrás graduada
face arrière graduée
lato posteriore graduato

1/2

Ochsenbein
43-885-03-07

Elevator, Raspatorium

Elevator, raspatory

Elevador, legra

Elevateur, rugine raspatoire

Elevatore, elevatore periostale



Obwegeser
48-135-21-07
21 cm / 8 2/8"



Obwegeser
48-137-21-07
21 cm / 8 2/8"