

Amalgaminstrumente

Amalgam instruments
Instrumentos amalgamas
Instruments à amalgame
Strumenti per amalgama



44-185-01-01

Amalgampistole
Amalgam carrier
Porta amalgamas
Pistolet pour amalgame
Cucchiaino portamalgame

leicht gebogen
slightly curved
ligeramente curvo
légèrement courbé
leggermente curvo



44-187-01-01

Amalgampistole
Amalgam carrier
Porta amalgamas
Pistolet pour amalgame
Cucchiaino portamalgame

gewinkelt
angled
acodado
coudé
angolato



44-187-05-04

Kunststoffansatz allein zu 44-185-01 und 44-187-01
Plastic tip alone for 44-185-01 and 44-187-01
Sólo aditamento de plástico para 44-185-01 y 44-187-01
Appendice en plastique uniquement pour 44-185-01 et 44-187-01
Accessorio in plastica per 44-185-01 e 44-187-01



44-200-30-01

Amalgam-Fingerbecher, Boden flach
Amalgam finger bowl, bottom flat
Vaso para dedos de amalgama, base plana
Coupelle pour amalgame, fond plat
Vaso di amalgama, base piana



44-200-31-01

Amalgam-Fingerbecher, Boden rund
Amalgam finger bowl, bottom round
Vaso para dedos de amalgama, base redonda
Coupelle pour amalgame, fond rond
Vaso di amalgama, base tonda

Füllungsinstrumente

Filling instruments

Instrumentos para obturaciones

Instruments pour plombages

Otturatori

Füllungsinstrumente

Filling instruments

Instrumentos para obturaciones

Instruments pour plombages

Otturatori

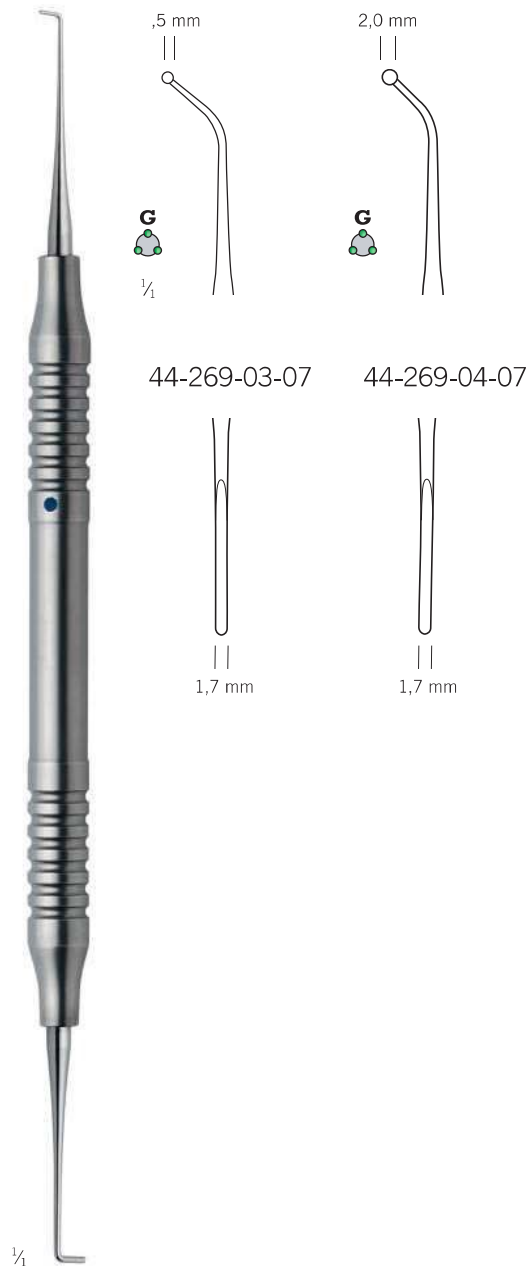
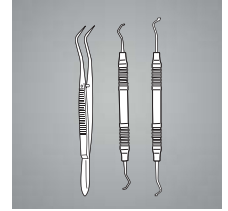

Zürich
44-269-03-07 -
44-269-04-07

17 cm / 6 5/8"

Kugelstopfer/Spatel-Kombination
Ball type condenser/spatula combination
Combinación condensador tipo bola/espátula
Combinaison obturateur à bille/spatule
Combinazione spatola/otturatore a sfera

Hohlgriff, 8 mm
hollow handle, 8 mm
mango hueco, 8 mm
poignée creuse, 8 mm
manico cavo, 8 mm

Ideal für Füllungen von retrograd mit MTA oder Super EBA
Ideal for retrograde fillings with MTA and Super EBA
Ideal para empastes retrógrados con MTA y Super EBA
Idéal pour le remplissage rétrograde avec du matériel MTA et Super EBA
Ideale per otturazioni retrograde con MTA e Super EBA

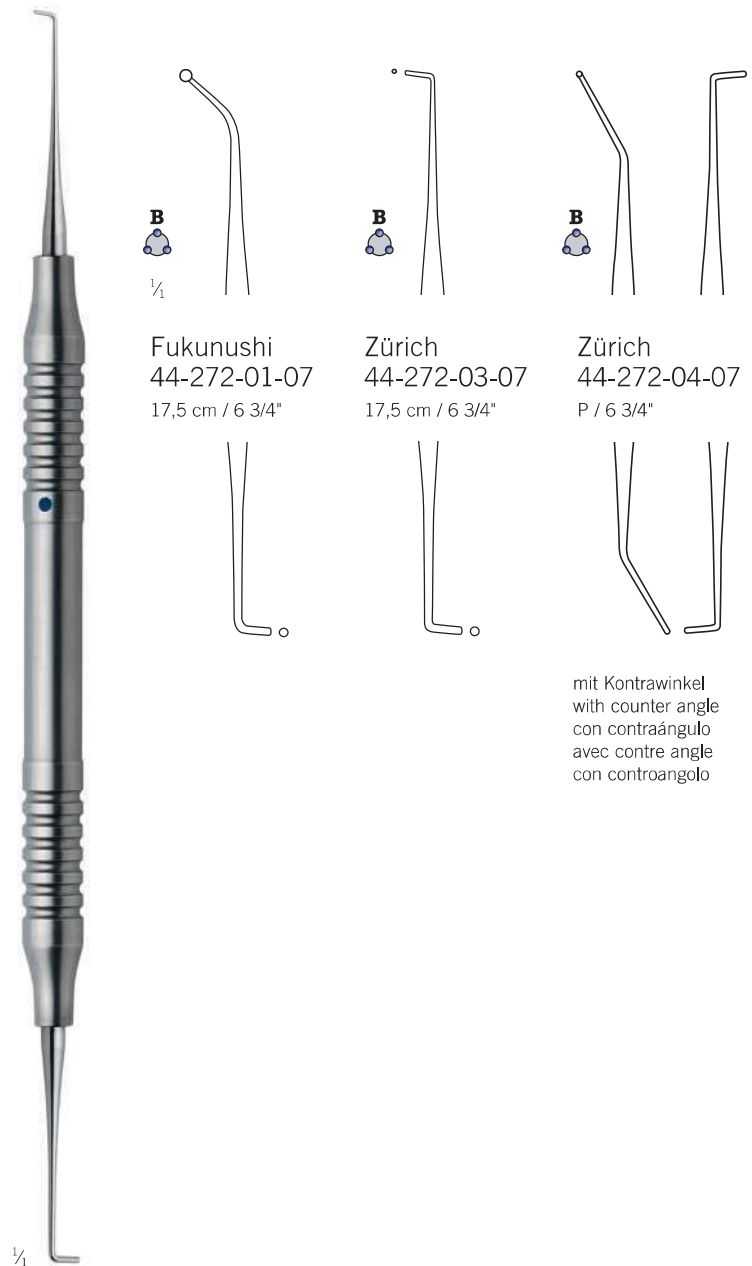

44-272-01-07 -
44-272-04-07

16,5 cm / 6 4/8"

Planstopfer "Retrograd"
Plane condenser "Retrograd"
Condensador plano "Retrograd"
Obturateur plan "Retrograd"
Otturatore piano "Retrograd"

Hohlgriff, 8 mm
hollow handle, 8 mm
mango hueco, 8 mm
poignée creuse, 8 mm
manico cavo, 8 mm

Ideal für Füllungen von retrograd mit MTA oder Super EBA
Ideal for retrograde fillings with MTA and Super EBA
Ideal para empastes retrógrados con MTA y Super EBA
Idéal pour le remplissage rétrograde avec du matériel MTA et Super EBA
Ideale per otturazioni retrograde con MTA e Super EBA

mit Kontrawinkel
with counter angle
con contraángulo
avec contre angle
con controangolo

Kompositinstrument

Composite instrument
 Instrumento compuesto
 Instrument composite
 Strumento composto



1/4

44-330-01-07 -
 44-332-04-07

17,5 cm / 6 7/8"

titanbeschichtet, massiver Griff, 6 mm
 titanium coated, solid handle, 6 mm
 con revestimiento de titanio, mango sólido, 6 mm
 revêtu de titane, poignée massive, 6 mm
 con rivestimento in titanio, solida impugnatura, 6 mm

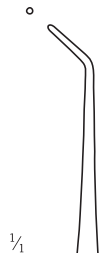

44-330-01-07
 Fig. 1

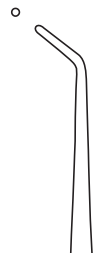

44-330-02-07
 Fig. 2



44-330-03-07
 Fig. 3



1/4

44-330-04-07
 Fig. 4



44-330-05-07
 Fig. 5



44-330-10-07
 Fig. 10



⊙



⊙

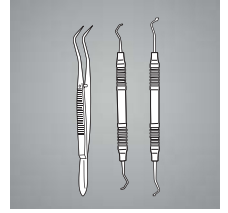

Felt
 44-332-01-07
 Fig. 1

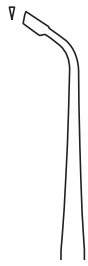

Felt
 44-332-02-07
 Fig. 2

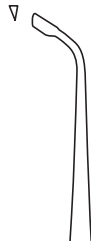

Felt
 44-332-03-07
 Fig. 3



Felt
 44-332-04-07
 Fig. 4

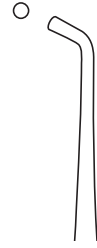

Felt
 44-332-05-07
 Fig. 5



Felt
 44-332-06-07
 Fig. 6



Goldstein
 44-334-01-07
 Fig. 1

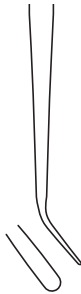

Goldstein
 44-334-02-07
 Fig. 2



Goldstein
 44-334-03-07
 Fig. 3



Goldstein
 44-334-04-07
 Fig. 4



titanbeschichtet
 nichthaftend
 titanium coated
 non adhesive
 con revestimiento
 de titanio
 no adhesivo
 recouvert de titane
 non adhésif
 con rivestimento
 in titanio
 non adesivo

Kompositinstrument

Composite instrument
Instrumento compuesto
Instrument composite
Strumento composito

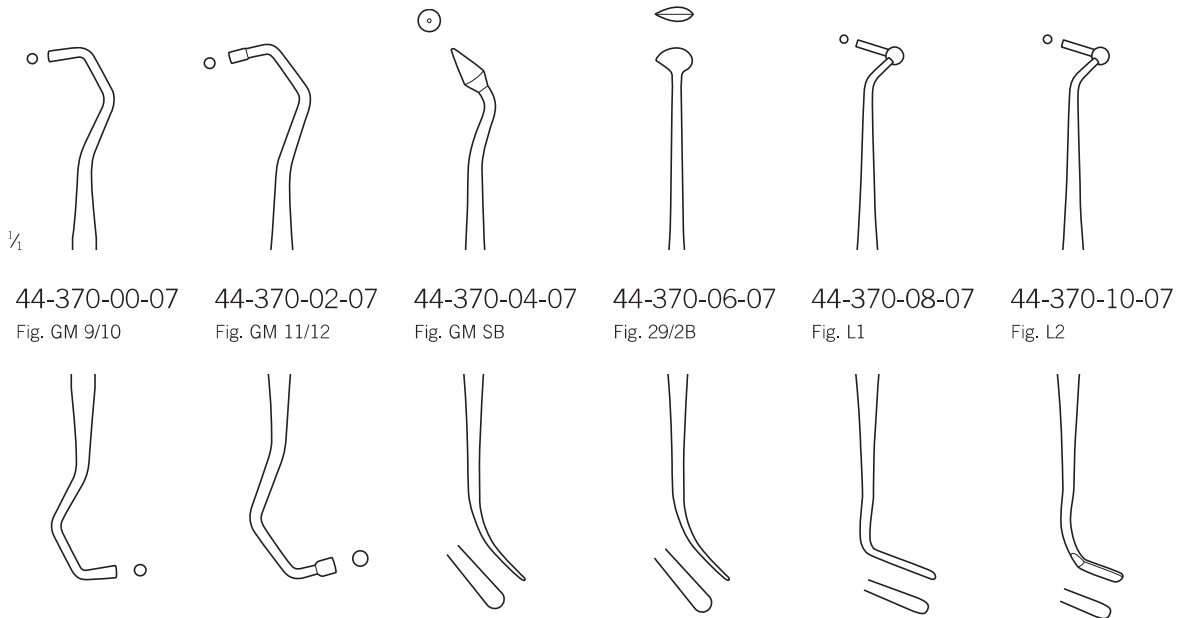

44-370-00-07 -
44-370-10-07

17,5 cm / 6 7/8"

massiver Griff, 6 mm
solid handle, 6 mm
mango sólido, 6 mm
poignée massive, 6 mm
solida impugnatura, 6 mm

Elefantenfußstopfer

Elephant foot condenser
Condensador pie de elefante
Obturateur pied d'éléphant
Otturatore a piede di elefante

Füllungsinstrumente

Filling instruments
Instrumentos para obturaciones
Instruments pour plombages
Otturatori

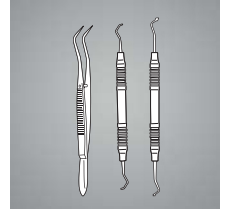

1/4

44-375-00-07

Fig. 0



44-375-01-07

Fig. 1



44-375-02-07

Fig. 2



1/4

44-375-00-07 -
44-375-02-07

17,5 cm / 6 7/8"

massiver Griff, 6 mm
solid handle, 6 mm
mango sólido, 6 mm
poignée massive, 6 mm
solida impugnatura, 6 mm

Kugelstopfer, Polierinstrumente

Ball type condenser, polisher

Condensador tipo bola, instrumentos para pulir

Obturateur à bille, polissoir

Otturatore a sfera, lucidatore



44-377-01-07

Fig. 1



44-377-02-07

Fig. 2



44-377-03-07

Fig. 3



44-377-04-07

Fig. 4



44-377-05-07

Fig. 5



44-377-18-07

Fig. 18



44-377-27-07

Fig. 26/27S



44-377-28-07

Fig. 28/29



44-377-29-07

Fig. 27/29

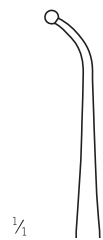

1/4



44-377-01-07 -
44-377-29-07

17,5 cm / 6 7/8"

massiver Griff, 6 mm

solid handle, 6 mm

mango sólido, 6 mm

poignée massive, 6 mm

solida impugnatura, 6 mm

Polierinstrument
Polisher
Instrumento para pulir
Polissoir
Lucidatore

Planstopfer

Plane condenser
Condensador plano
Obturateur plan
Otturatore piano

Füllungsinstrumente

Filling instruments
Instrumentos para obturaciones
Instruments pour plombages
Otturatori

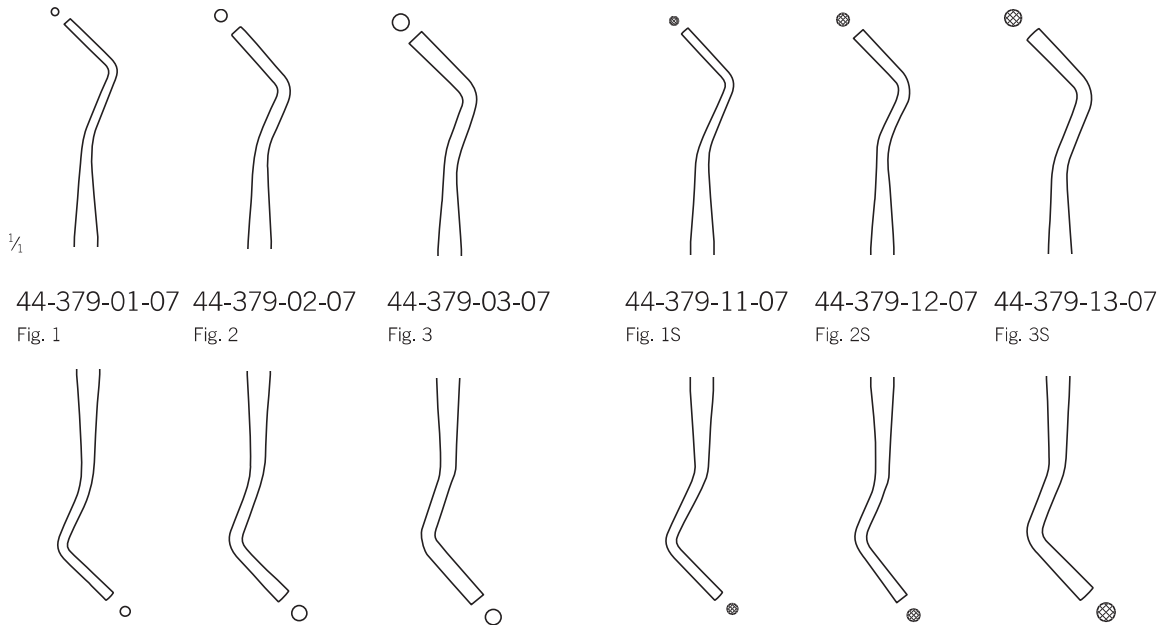
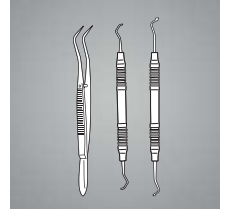

44-379-01-07

Fig. 1

44-379-02-07

Fig. 2

44-379-03-07

Fig. 3

44-379-11-07

Fig. 1S

44-379-12-07

Fig. 2S

44-379-13-07

Fig. 3S

44-379-01-07 -
44-379-13-07

17,5 cm / 6 7/8"

massiver Griff, 6 mm
solid handle, 6 mm
mango sólido, 6 mm
poignée massive, 6 mm
solida impugnatura, 6 mm

Füllungsinstrumente

Filling instruments
Instrumentos para obturaciones
Instruments pour plombages
Otturatori



44-380-02-07
Fig. 1S



44-380-04-07
Fig. 2S

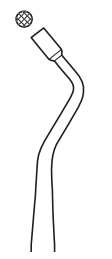

44-380-06-07
Fig. 3S



44-380-08-07
Fig. 4S



gerieft
fluted
acanalado
cannelé
scanalato



gerieft
fluted
acanalado
cannelé
scanalato



gerieft
fluted
acanalado
cannelé
scanalato



gerieft
fluted
acanalado
cannelé
scanalato



44-380-10-07
Fig. 1P



44-380-12-07
Fig. 2P

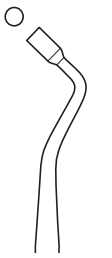

44-380-14-07
Fig. 3P



44-380-16-07
Fig. 4P



1/4

44-380-02-07 -
44-380-32-07
17,5 cm / 6 7/8"
massiver Griff, 6 mm
solid handle, 6 mm
mango sólido, 6 mm
poignée massive, 6 mm
solida impugnatura, 6 mm

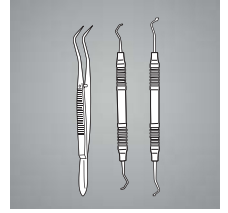

1/1
 44-380-18-07
 Fig. 1D



44-380-20-07
 Fig. 2D



44-380-22-07
 Fig. 3D



44-380-24-07
 Fig. M1



44-380-26-07
 Fig. M2

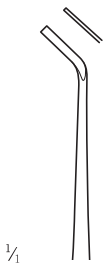

1/1
 44-380-28-07
 Fig. M3



44-380-30-07
 Fig. M4



44-380-32-07
 Fig. M5

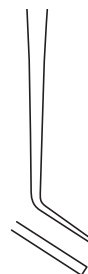
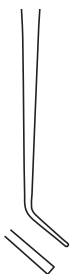

Füllungsinstrumente

Filling instruments
Instrumentos para obturaciones
Instruments pour plombages
Otturatori



44-380-28-07 -
44-380-52-07
17,5 cm / 6 7/8"
massiver Griff, 6 mm
solid handle, 6 mm
mango sólido, 6 mm
poignée massive, 6 mm
solida impugnatura, 6 mm



Hollenback
44-380-36-07
Fig. H 1

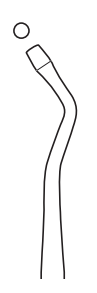

Hollenback
44-380-38-07
Fig. H 2



Hollenback
44-380-40-07
Fig. H 3



Hollenback
44-380-42-07
Fig. H 4



44-380-44-07
Fig. MQ 1S



44-380-46-07
Fig. T 0



44-380-48-07
Fig. T 1



44-380-50-07
Fig. T 2



44-380-52-07
Fig. T 3



gerieft
fluted
acanalado
cannelé
scanalato

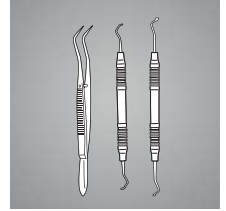

¼



44-382-01-07
Fig. 1



44-382-02-07
Fig. 2



44-382-03-07
Fig. 3

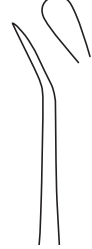

44-384-01-07
Fig. WO 1



44-384-02-07
Fig. WO 2



44-384-03-07
Fig. WO 3



44-386-02-07
Fig. L 2



44-386-03-07
Fig. L 3



Ward
44-388-01-07
Fig. 1



Ward
44-388-02-07
Fig. 2



¼

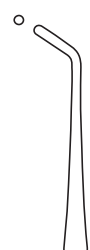

¼

44-382-01-07 -
44-388-02-07
17,5 cm / 6 7/8"
massiver Griff, 6 mm
solid handle, 6 mm
mango sólido, 6 mm
poignée massive, 6 mm
solida impugnatura, 6 mm

Kugel/Spatel-Kombination

Ball/spatula combination
 Combinación bola/espátula
 Combinaison bille/spatule
 Combinazione sfera/spatola

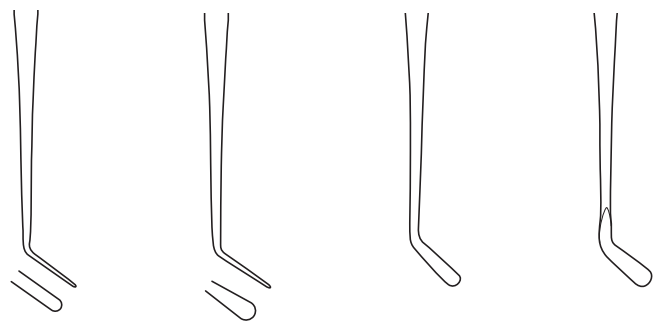
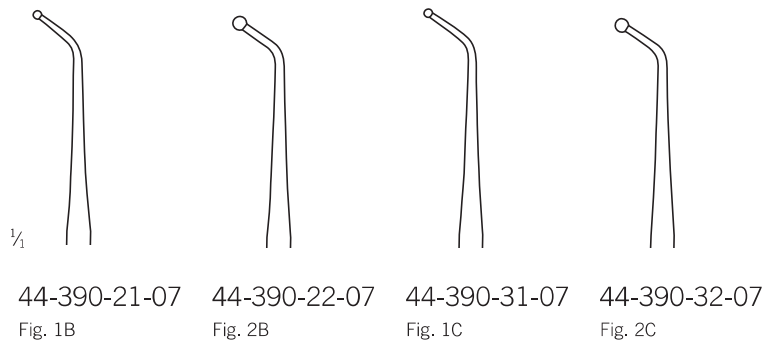
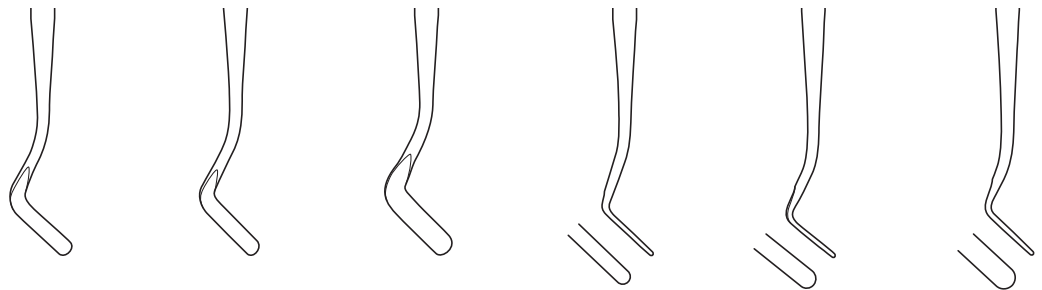
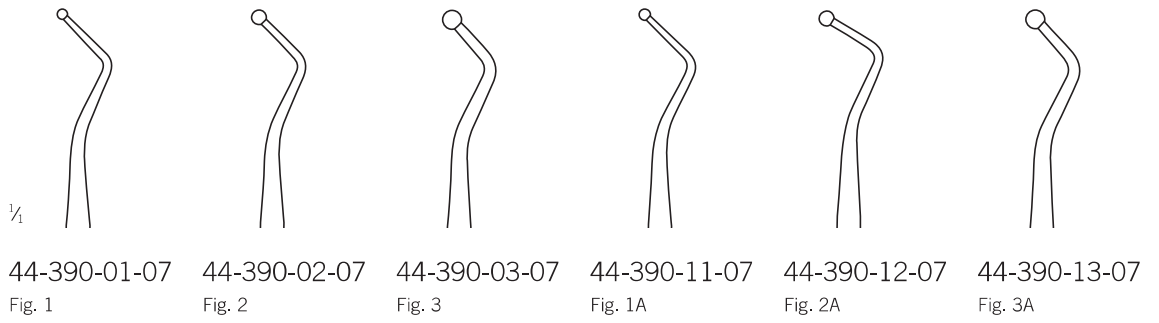

44-390-01-07 -
 44-390-32-07
 17,5 cm / 6 7/8"
 massiver Griff, 6 mm
 solid handle, 6 mm
 mango sólido, 6 mm
 poignée massive, 6 mm
 solida impugnatura, 6 mm

Spatel

Spatula
Espátula
Spatule
Spatola

Füllungsinstrumente

Filling instruments
Instrumentos para obturaciones
Instruments pour plombages
Otturatori

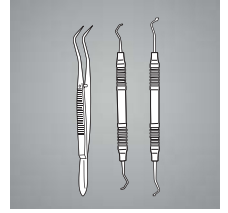

44-392-01-07
Fig. 1



44-392-02-07
Fig. 2



44-392-03-07
Fig. 3



44-392-10-07
Fig. 10



44-392-11-07
Fig. 11A



44-392-12-07
Fig. 12



44-392-13-07
Fig. 13



44-392-01-07 -
44-392-13-07

17,5 cm / 6 7/8"

massiver Griff, 6 mm
solid handle, 6 mm
mango sólido, 6 mm
poignée massive, 6 mm
solida impugnatura, 6 mm

Füllungsinstrumente

Filling instruments

Instrumentos para obturaciones

Instruments pour plombages

Otturatori

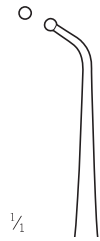

44-394-07-07
Fig. 7A

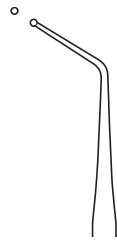

44-394-19-07
Fig. 19

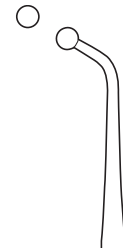

44-394-77-07
Fig. 7B

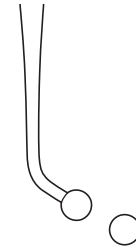
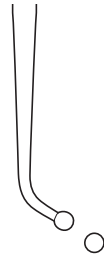

44-396-06-07
Fig. 6



44-396-11-07
Fig. 11



44-396-79-07
Fig. 179



44-394-07-07 -
44-396-79-07

17,5 cm / 6 7/8"

massiver Griff, 6 mm
solid handle, 6 mm
mango sólido, 6 mm
poignée massive, 6 mm
solida impugnatura, 6 mm

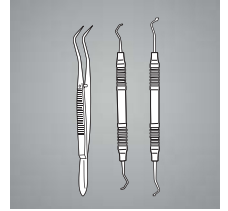

Heidemann
 44-398-01-07 -
 44-399-13-07
 17,5 cm / 6 7/8"
 massiver Griff, 6 mm
 solid handle, 6 mm
 mango sólido, 6 mm
 poignée massive, 6 mm
 solida impugnatura, 6 mm



44-398-01-07
 Fig. 1
 2,0 mm



44-398-02-07
 Fig. 2
 2,5 mm



44-398-04-07
 Fig. 3
 3 mm



44-399-11-07
 Fig. 11
 2,0 mm



44-399-12-07
 Fig. 12
 2,5 mm



44-399-13-07
 Fig. 13
 3,0 mm



1/4



1/4



1/4



scharf
 sharp
 afilado
 affilé
 affilato



scharf
 sharp
 afilado
 affilé
 affilato



scharf
 sharp
 afilado
 affilé
 affilato

Mini-Zementspatel

Mini cement mixing spatula

Mini espátula para cemento

Mini spatule à plâtre

Mini spatola per cemento



1/4



44-438-01-07
Fig. 1A



44-438-02-07
Fig. 2A



44-438-03-07
Fig. 3A



44-438-14-07
Fig. 4



44-442-00-07
Fig. 00



44-442-01-07
Fig. 0

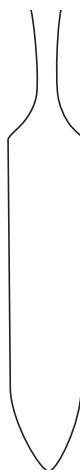

1/4

Zürich
44-438-01-07 -
44-442-01-07

17,5 cm / 6 7/8"

Hohlgriff, 8 mm
hollow handle, 8 mm
mango hueco, 8 mm
poignée creuse, 8 mm
manico cavo, 8 mm

Zementspatel, Silikatspatel

Cement mixing spatula, silicate mixing spatula

Espátula para mezclar, espátula de silicato

Spatule à plâtre, spatule à silicate

Spatola per cemento, spatola per la mescolatura di silicone

Füllungsinstrumente

Filling instruments

Instrumentos para obturaciones

Instruments pour plombages

Otturatori

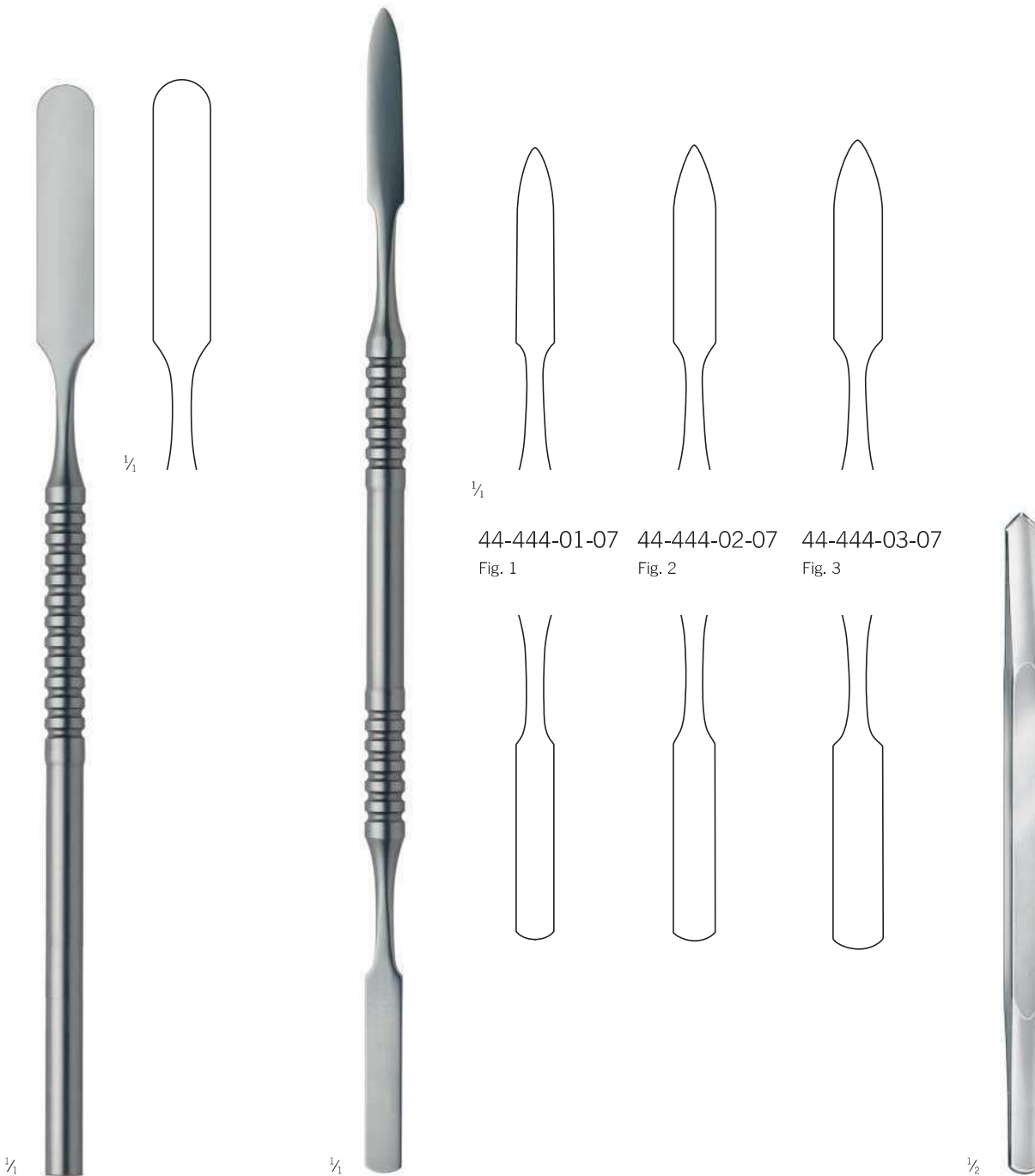
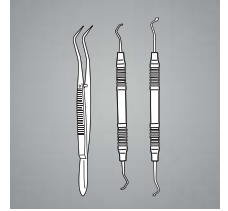

44-440-02-07

17 cm / 6 5/8"

massiver Griff, 6 mm
solid handle, 6 mm
mango sólido, 6 mm
poignée massive, 6 mm
solida impugnatura, 6 mm

Martin

44-444-01-07 - 44-444-03-07

17,5 cm / 6 7/8"

Zementspatel, 6 mm, massiver Griff
Cement mixing spatula, 6 mm, solid handle
Espátula para cemento, mango sólido de 6 mm
Spatule à plâtre, poignée massive de 6 mm
Spatola per cemento, solida impugnatura da 6 mm

44-457-01-04

17,5 cm / 6 7/8"

Silikatspatel, aus Kunststoff
Silicate spatula, plastic
Espátula de silicato, de plástico
Spatule à silicate, en plastique
Spatola di silicone, in plastica

Matrizen und Matrizenspanner

Matrix bands and retainers

Portamatrices y matrices

Porte matrices et matrices

Portamatrici eatrici



1/2

Ivory
44-465-01-07

Fig. 1



1/2

Ivory
44-467-01-07

Fig. 12



1/2

Ivory
44-468-01-07

Fig. 12A



1/2

Ivory	
44-480-05-07	5 mm
44-480-06-07	6 mm
44-480-07-07	7 mm

1/1



44-470-01-07

Fig. 1



44-470-04-07

Fig. 4



44-470-02-07

Fig. 2



44-470-05-07

Fig. 5



44-470-03-07

Fig. 3



44-470-06-07

Fig. 6

für Molaren, 12 Stück
for molars, 12 pieces
para molares, 12 piezas
pour molaires, 12 pièces
per molari, 12 pezzi

für Prämolaren, 12 Stück
for premolars, 12 pieces
para premolares, 12 piezas
pour prémolaires, 12 pièces
per premolari, 12 pezzi

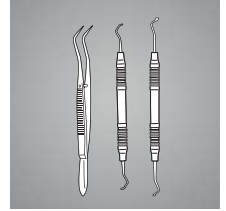

44-481-01-07
 Junior

44-481-05-07
 Universal

Tofflemire
 44-481-01-07 - 44-481-05-07

1/1

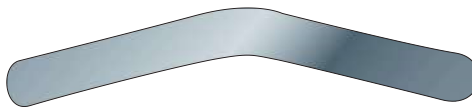

Tofflemire
 44-482-01-07

Fig. 1
 12 Stück
 12 pieces
 12 piezas
 12 pièces
 12 pezzi



Tofflemire
 44-482-13-07

Fig. 13
 12 Stück
 12 pieces
 12 piezas
 12 pièces
 12 pezzi

1/1



44-484-07-07
 Fig. 7



44-484-08-07
 Fig. 8

für Molaren, 12 Stück
 for molars, 12 pieces
 para molares, 12 piezas
 pour molaires, 12 pièces
 per molari, 12 pezzi



44-484-09-07
 Fig. 9



44-484-10-07
 Fig. 10



44-484-11-07
 Fig. 11



44-484-12-07
 Fig. 12



44-484-13-07
 Fig. 13



1/2

- 44-485-05-07 5 mm x 1 m
- 44-485-06-07 6 mm x 1 m
- 44-485-07-07 7 mm x 1 m

Kofferdam-Instrumente

Rubber dam instruments

Dique de goma

Instruments kofferdam

Kofferdam



1/2

Ainsworth
44-500-16-07

16 cm / 6 1/8"

Kofferdam-Lochzange

Punch forceps

Perforadores

Pinces à perforer

Pinze foradiga



1/2

USA
44-502-15-07

15 cm / 5 7/8"

Kofferdam-Lochzange

Punch forceps

Perforadores

Pinces à perforer

Pinze foradiga



1/2

Ivory
44-506-16-07

16 cm / 6 1/8"

Kofferdam-Klammerzange

Clamp forceps

Portaclamps

Pinces porte crampons

Pinze per uncini



1/2

Brewer
44-513-17-07

17 cm / 6 5/8"

Kofferdam-Lochzange

Punch forceps

Perforadores

Pinces à perforer

Pinze foradiga



1/2

Stockes
44-503-17-07

17 cm / 6 5/8"

Kofferdam-Lochzange

Punch forceps

Perforadores

Pinces à perforer

Pinze foradiga

Kofferdam-Instrumente

Rubber dam instruments

Dique de goma

Instruments kofferdam

Kofferdam

Füllungsinstrumente

Filling instruments

Instrumentos para obturaciones

Instruments pour plombages

Otturatori

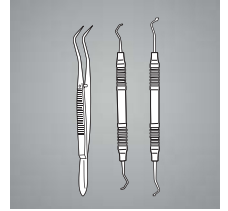

1/2

Wizard

44-520-00-02

Fig. 60

Kofferdam-Halter

Rubber dam holder

Sostenedor

Porte digues

Supporto per kofferdam



1/4

Ivory

44-515-26-07

Fig. 26

44-515-27-07

Fig. 27

44-515-28-07

Fig. 28

44-515-29-07

Fig. 29



1/4

44-515-30-07

Fig. 30

44-515-31-07

Fig. 31

44-515-51-07

Fig. 51

44-515-60-07

Fig. 60