

**BONE**<sup>®</sup>  
**SYSTEM**



International Catalog

**CONTENTS:**

<b>1 - Implants and Surgery .....</b>	<b>4</b>
1.1. 2P Implants - 2-Principle .....	4
1.2. RF Implants - Root Form .....	6
1.3. "One-Stage" Implants .....	8
1.4. "QM" Implants - Quick Mounted.....	10
1.5. Guided Surgery - Software and Instruments.....	12
1.6. Complements for Surgery .....	13
1.7. Components for Impression taking.....	13
1.8. Surgical and Prosthetic Instruments .....	13
<b>2 - Laboratory and Prosthetics.....</b>	<b>16</b>
2.1. "Friction Locking" components for cemented crowns and bridges ....	16
2.2. "Friction Locking" components for screwed crowns and bridges.....	17
2.3. Laboratory tools and materials for "Friction Locking" .....	18
2.4. Components for prosthesis "Easy-On-Four" .....	19
<b>3 - Surgical Workflows.....</b>	<b>21</b>
3.1. Handling and insertion of the implants.....	21
<b>4 - Prosthetic Workflows for single Crowns and Bridges .....</b>	<b>24</b>
4.1. Temporary Elements .....	24
4.2. Taking the impression .....	25
4.3. The Bone System Screwed Connections.....	29
4.4. Bridges and Crowns cemented on "Friction Locking" Abutment.....	31
4.5. Single Crowns and Bridges screwed on "Friction Locking" Links .....	34
4.6. Prosthetic procedure "Easy-On-Four" .....	36
4.7. Smart Digital Solutions .....	40

# **BONE**<sup>®</sup> **SYSTEM**

## International Catalog **PRODUCTS & OPERATIONS**

### ***Intuition and our vision:***

*the maintenance of soft tissues is fundamental in implant treatment and our genesis originates from this assumption.*

*We understand implantology not only as osseointegration, but as respect for the healing processes, to safeguard the connective tissue during healing, in absolute respect of biological width.*

*Thanks to thirty years of studies and clinical experiences, we have demonstrated the effectiveness of our vision:*

***science guided by the symbiosis between anatomy and biology.***

## 1.1. 2P Implants - 2-Principle

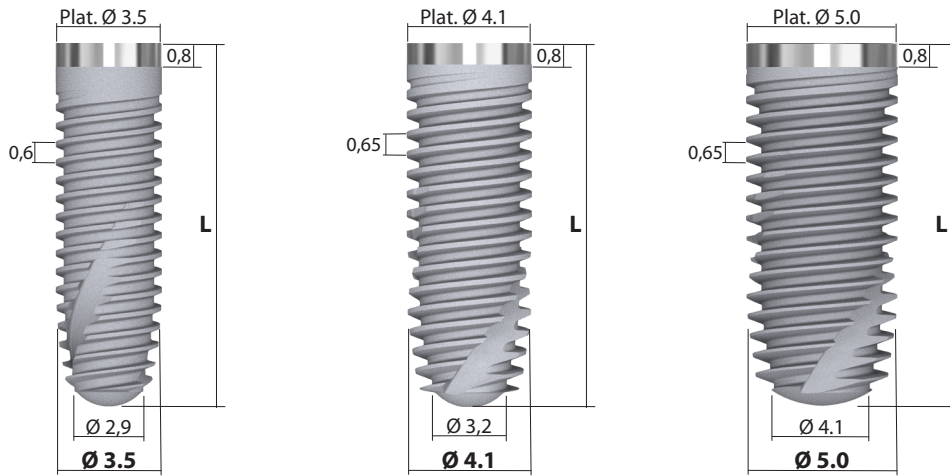

### 1.1.1 Features

- **The 2P Ø 3.5 implant** is intended for use in cases of reduced crestal width and in areas with reduced mesial/distal space. It is not recommended for use in the posterior sectors.
- **The 2P Ø 4.1 and 5.0 implants** implants are characterized by a morphology of the implant body and thread suitable for achieving excellent primary stability with minimal effort for the operator, making them particularly suitable for immediate loading.

### 1.1.2 Surgical protocols

**NOTE** - The rationalization of the profiles of the preparation drills, in relation to the morphology of the implant body, allows the use of the same progressive drills and the application of the same protocols with all Bone System 2P - RF - One Stage - QM implants.

This means that the same instrument tray can be used for all implants, with an important saving in costs and time for its management.

The "2P" implant preparation protocol is aimed at obtaining maximum primary stability over the entire implant length, with minimum stress, in every bone quality.

A further passage is provided in situations of particularly dense bone type D1-D2, by using a progressive cutter Ø 4.3 or Ø 5.3 "CORTICAL", with a stop that limits the depth to a maximum of 5 mm.

PHASE	Pilot Drill	Check Axis	Preparation of the implant site				
Ø 3.5 Implant			●	–	–	–	–
Ø 4.1 Implant	●	●	●	●	●	–	–
Ø 5.0 Implant			●	●	–	●	●
Operativ steps							
Drill Ø	2.0	–	3.5	4.1	4.3 cort	5.0	5.3 cort
Speed RPM	200/300	–	200/300	200/300	200/300	200/300	200/300

● = Recommended    ● = Optional for D1-D2 bone density

### 1.1.3 Product Directory

#### ● "2P" Implants

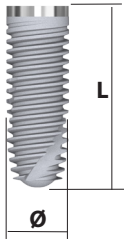

Ø	L	Code	Q.ty	Material	Notes
3.5	10	13K00101	1	Titanium	The package includes the plug screw.
	12	13K00201	1		
	13.5	13K00301	1		
	15	13K00401	1		
4.1	8.2	13K10101	1	Titanium	The package includes the plug screw.
	10	13K10201	1		
	12	13K10301	1		
	13.5	13K10401	1		
	15	13K10501	1		
5.0	8.2	13K20101	1	Titanium	The package includes the plug screw.
	10	13K20201	1		
	12	13K20301	1		
	13.5	13K20401	1		
	15	13K20501	1		

#### ● Twist Drills Ø 2.0 with Fixed Stop

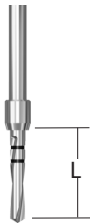

Ø	L	Code	Q.ty	Material	Notes
2.0	8.2	20201001	1	Stainless Steel	-
	10	20201101	1		
	12	20201201	1		
	13.5	20201301	1		
	15	20201401	1		

#### ● Progressive Drills with Stop

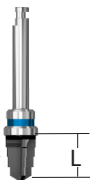

Ø	L	Code	Q.ty	Material	Notes
3.5	8.2	20101901	1	Stainless Steel	Coating DLC*
	10	20100701	1		
	12	20100801	1		
	13.5	20100901	1		
	15	20101701	1		
4.1	8.2	20102001	1	Stainless Steel	Coating DLC*
	10	20101001	1		
	12	20101101	1		
	13.5	20101201	1		
	15	20101801	1		
5.0	8.2	20102101	1	Stainless Steel	Coating DLC*
	10	20101301	1		
	12	20101401	1		
	13.5	20101501	1		
	15	20101601	1		
4.3 cortical	5	20102501	1	Stainless Steel	For implants from 8.2 to 15 mm
5.3 cortical	5	20102601	1		

\* DLC = Diamond Like Carbon, Carbon-based coating to reduce friction and heat transferred to the bone and increase the cutting capacity and durability of the cutting edges.

## 1.2. RF Implants - Root Form

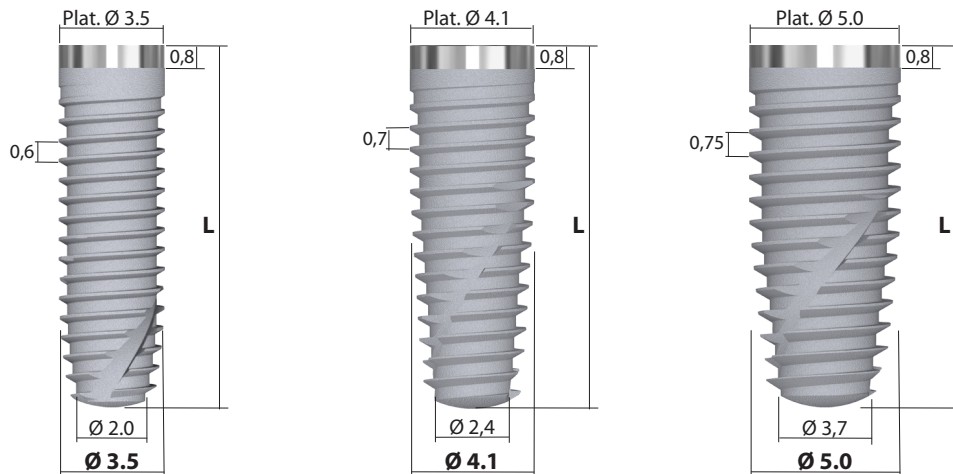

### 1.2.1 Features

● **The RF Ø 3.5 implant** is a suitable implant for use in cases of reduced crestal width and in areas with reduced mesio/distal space, in unfavorable anatomical conditions and in the presence of converging roots, when it is necessary to take advantage of the opportunities offered by conical morphology. It is not recommended for use in the posteriors sectors.

● **With RF implants Ø 4.1 - 5.0** the opportunities offered by the conical morphology of the implant are particularly important in cases of Controlled Bone Expansion or Split-Crest, in the immediate loading and in the large and mini lift of the floor of the maxillary sinus.

### 1.2.2 Surgical protocols

**NOTE** - The rationalization of the profiles of the preparation drills, in relation to the morphology of the implant body, allows the use of the same progressive drills and the application of the same protocols with all Bone System 2P - RF - One Stage - QM implants.

This means that the same instrument tray can be used for all implants, with an important saving in costs and time for its management.

The "RF" implant preparation protocol is aimed at obtaining maximum primary stability over the entire implant length, with minimum stress, in every bone quality.

A further passage is provided in situations of particularly dense bone type D1-D2, by using a progressive cutter Ø 4.3 or Ø 5.3 "CORTICAL", with a stop that limits the depth to a maximum of 5 mm.

PHASE	Pilot Drill	Check Axis	Preparation of the implant site				
Ø 3.5 Implant	●	●	●	—	—	—	—
Ø 4.1 Implant	●	●	●	●	●	—	—
Ø 5.0 Implant	●	●	●	●	—	●	●
Operativ steps							
Drill Ø	2.0	—	3.5	4.1	4.3 cort	5.0	5.3 cort
Speed RPM	200/300	—	200/300	200/300	200/300	200/300	200/300

● = Recommended    ● = Optional for D1-D2 bone density

### 1.2.3 Product Directory

#### ● "RF" Implants

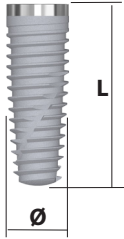

Ø	L	Code	Q.ty	Material	Notes
3.5	10	11K10101	1	Titanium	The package includes the plug screw.
	12	11K10201	1		
	13.5	11K10301	1		
	15	11K10401	1		
4.1	10	11K20101	1	Titanium	The package includes the plug screw.
	12	11K20201	1		
	13.5	11K20301	1		
	15	11K20401	1		
5.0	10	11K30101	1	Titanium	The package includes the plug screw.
	12	11K30201	1		
	13.5	11K30301	1		

#### ● Twist Drills Ø 2.0 with Fixed Stop

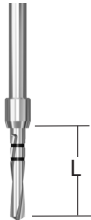

Ø	L	Code	Q.ty	Material	Notes
	10	20201101	1	Stainless Steel	-
	12	20201201	1		
	13.5	20201301	1		
	15	20201401	1		

#### ● Progressive Drills with Stop

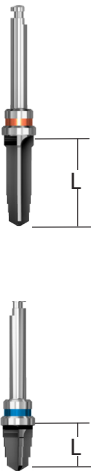

Ø	L	Code	Q.ty	Material	Notes
3.5	10	20100701	1	Stainless Steel	Coating DLC*
	12	20100801	1		
	13.5	20100901	1		
	15	20101701	1		
4.1	10	20101001	1	Stainless Steel	Coating DLC*
	12	20101101	1		
	13.5	20101201	1		
	15	20101801	1		
5.0	10	20101301	1	Stainless Steel	Coating DLC*
	12	20101401	1		
	13.5	20101501	1		
4.3 cortical	5*	20102501	1	Stainless Steel	For implants from 8.2 to 15 mm
5.3 cortical	5*	20102601	1		

\* DLC = Diamond Like Carbon, Carbon-based coating to reduce friction and heat transferred to the bone and increase the cutting capacity and durability of the cutting edges.

### 1.3. "One-Stage" Implants

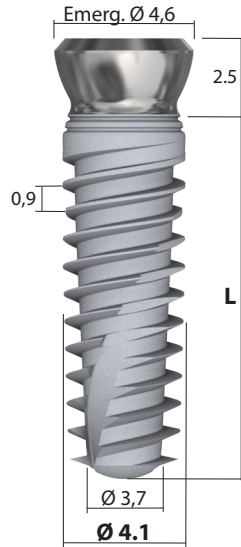

#### 1.3.1 Features

● **The One-Stage implant** was born from the need of the users to have an implant that would allow them to implement a non-submerged surgical technique, in all cases in which the anatomy and the clinical situation of the patient made it not only feasible but preferable for the management of the case. In fact, with a transmucosal technique the number of sessions and the time of rehabilitation are reduced, with undoubted clinical and economic advantages due to the simplification of procedures compared to a submerged approach.

● **The One Stage implant** consists of a rough-endosseous portion (L) and a natural smooth transmucosal path (2.5 mm); this implant morphology allows to position the emergence profile from the soft tissues approximately at the coronal level, so as to be in the optimal position according to the gingival biotype of the patient and in the most favorable condition to receive the prosthetic element.

#### 1.3.2 Surgical protocols

**NOTE** - The rationalization of the profiles of the preparation drills, in relation to the morphology of the implant body, allows the use of the same progressive drills and the application of the same protocols with all Bone System 2P - RF - One Stage - QM implants.

This means that the same instrument tray can be used for all implants, with an important saving in costs and time for its management.

The "One-Stage" implant preparation protocol is aimed at obtaining maximum primary stability over the entire implant length, with minimum stress, in every bone quality.

A further passage is provided in situations of particularly dense bone type D1-D2, by using a progressive cutter Ø 4.3 or Ø 5.3 "CORTICAL", with a stop that limits the depth to a maximum of 5 mm.

PHASE	Pilot Drill	Check Axis	Preparation of the implant site		
Ø 4.1 Implant	●	●	●	●	●
Operativ steps					
Drill Ø	2.0	-	3.5	4.1	4.3 cort
Speed RPM	200/300	-	200/300	200/300	200/300

● = Recommended    ● = Optional for D1-D2 bone density



### 1.3.3 Product Directory

- "One-Stage" Implants

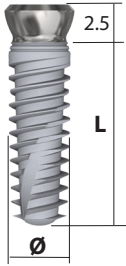

Ø	L	Code	Q.ty	Material	Notes
4.1	8.2	12K31601	1	Titanium	The package includes the plug screw.
	10	12K31701	1		
	12	12K31801	1		
	13.5	12K31901	1		

- Twist Drills Ø 2.0 with Fixed Stop

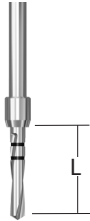

Ø	L	Code	Q.ty	Material	Notes
2.0	8.2	20201001	1	Stainless Steel	-
	10	20201101	1		
	12	20201201	1		
	13.5	20201301	1		

- Progressive Drills with Stop

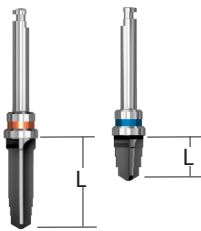

Ø	L	Code	Q.ty	Material	Notes
3.5	8.2	20101901	1	Stainless Steel	Coating DLC*
	10	20100701	1		
	12	20100801	1		
	13.5	20100901	1		
4.1	8.2	20102001	1	Stainless Steel	Coating DLC*
	10	20101001	1		
	12	20101101	1		
	13.5	20101201	1		
4.3 cortical	5*	20102501	1	Stainless Steel	For implants from 8.2 to 15 mm

\* DLC = Diamond Like Carbon, Carbon-based coating to reduce friction and heat transferred to the bone and increase the cutting capacity and durability of the cutting edges.

## 1.4. "QM" Implants - Quick Mounted

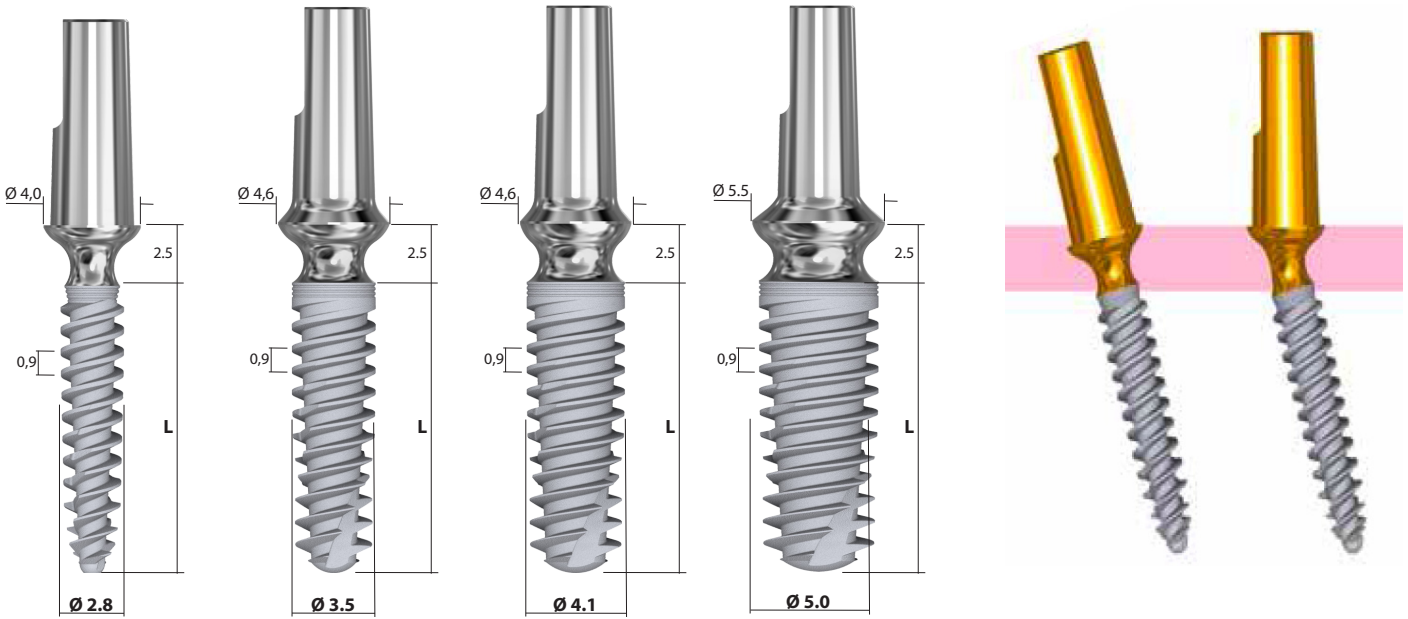

### 1.4.1 Features

- **QM implants** greatly simplify surgical and prosthetic procedures, allowing a significant reduction in treatment times and costs. The profile of the implant body has been specifically designed to produce an important grip in the bone, particularly useful in the application of immediate loading.
- **The transmucosal portion** with concave/convex profile is suitable to allow slight modifications of the axis of the emerging abutment, as well as favoring a better peri-implant biological seal.
- **The monolithic implant/abutment structure** eliminates the gap and any possibility of bacterial presence inside the implant.
- **The QM Ø 2.8 implant** finds its ideal use in monoedentulias with reduced mesio-distal spaces or in combination with other implants provided for in the treatment plan and in situations of reduced thickness of the bone crest.









### 1.4.2 Surgical protocols

**NOTE** - The rationalization of the profiles of the preparation drills, in relation to the morphology of the implant body, allows the use of the same progressive drills and the application of the same protocols with all Bone System 2P - RF - One Stage - QM implants.

This means that the same instrument tray can be used for all implants, with an important saving in costs and time for its management.

The "QM" implant preparation protocol is aimed at obtaining maximum primary stability over the entire implant length, with minimum stress, in every bone quality.

A further passage is provided in situations of particularly dense bone type D1-D2, by using a progressive cutter Ø 4.3 or Ø 5.3 "CORTICAL", with a stop that limits the depth to a maximum of 5 mm.

PHASE	Pilot Drill	Check Axis	Preparation of the implant site					
Ø 2.8 Implant	–	–	●	–	–	–	–	–
Ø 3.5 Implant	–	–	–	●	–	–	–	–
Ø 4.1 Implant	●	●	–	●	●	●	–	–
Ø 5.0 Implant	–	–	–	●	●	–	●	●
Operativ steps								
								
Drill Ø	2.0	–	1.7	3.5	4.1	4.3 cort	5.0	5.3 cort
Speed RPM	200/300	–	200/300	200/300	200/300	200/300	200/300	200/300

● = Recommended

● = Optional for D1-D2 bone density

### 1.4.3 Product Directory

#### ● "QM" Implants - Quick Mounted

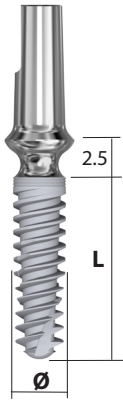

Ø	L	Code	Q.ty	Material	Notes
2.8	10	14M30201	1	Titanium	-
	12	14M30301	1		
	13.5	14M30401	1		
3.5	10	14M40201	1	Titanium	-
	12	14M40301	1		
	13.5	14M40401	1		
4.1	10	14M50201	1	Titanium	-
	12	14M50301	1		
	13.5	14M50401	1		
5.0	10	14M60201	1	Titanium	-
	12	14M60301	1		
	13.5	14M60401	1		

#### ● Twist Drill Ø 1.7

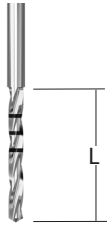

Ø	L	Code	Q.ty	Material	Notes
1.7	10	20020201	1	St. Steel	Final drill for Ø 2.8 Implants

#### ● Twist Drills Ø 2.0 with Fixed Stop

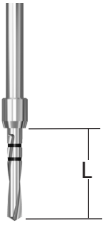

Ø	L	Code	Q.ty	Material	Notes
2.0	10	20201101	1	Stainless Steel	-
	12	20201201	1		
	13.5	20201301	1		

#### ● Progressive Drills with Stop

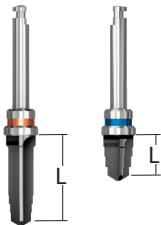

Ø	L	Code	Q.ty	Material	Notes
3.5	10	20100701	1	Stainless Steel	Coating DLC*
	12	20100801	1		
	13.5	20100901	1		
4.1	10	20101001	1	Stainless Steel	Coating DLC*
	12	20101101	1		
	13.5	20101201	1		
5.0	10	20101301	1	Stainless Steel	Coating DLC*
	12	20101401	1		
4.3 cortical	5*	20102501	1	Stainless Steel	For implants from 10 to 13.5 mm
5.3 cortical	5*	20102601	1		

\* DLC = Diamond Like Carbon, Carbon-based coating to reduce friction and heat transferred to the bone and increase the cutting capacity and durability of the cutting edges.

## 1.5. Guided Surgery - Software and Instruments

### ● Software "Bone System Guided Surgery"



Code	Q.ty	Notes
M03013D-BNS-01	1	For "2P" - "RF" implants Ø 3.5 e 4.1 mm, L = 10 - 12 - 13.5 mm.
For the computerized 3D planning of the treatment plan and the realization of the surgical guides for the preparation of the implant site and the insertion of the implants.		

### ● Surgical Tray



Size	Code	Q.ty	Material	Notes
190 x 138 x 61 mm	20408001*	1	Radel Plastic material	Suitable for sterilization in autoclave cycle B134°C Prions (134°C/2,15 Bar/18 min)
	20408032**	1		
* Without instruments				
** Supplied complete with all the instruments needed for the preparation of the implant site and the insertion of the "2P" and "RF" implants in guided surgery.				
- Individual instruments or drills are available on request.				

### ● Device for implant mounter



Size	Code	Q.ty	Material	Notes
70x15x30	70011601	1	Titanium	--
Device with 3 different diameters to stabilize the implant when applying the mounter.				



The digital planning, carried out with the Bone System 3D Guided Surgery software, gives a surgical approach based on objective data, for the use of "2P" and "RF" implants.

This three-dimensional implant diagnostic and planning software was created for the computer-guided planning of the surgical act, based on the combination of Dicom files obtained through a Cone Beam computed tomography of the patient (CBCT) and STL files obtained from the prosthetic design.

The software is able to make a 3D reconstruction, with great precision, of the patient's anatomy, highlighting the available spaces, bone quality as well as the anatomical structures to be respected, such as the alveolar nerve or the floor of the maxillary sinus.

The virtual analysis of the anatomy suggests the optimal positioning of the implants and allows to prepare the prosthetic components in the case of the immediate load.

The virtual images, obtained from the 3D reconstruction, contribute to the patient's sharing and acceptance of the treatment plan.

## 1.6. Complements for Surgery

### ● Healing Screws



Code	Q.ty	Material	Notes
30090101	1	Titanium	For implants Ø 3.5
30090201	1	Titanium	For implants Ø 4.1
30090301	1	Titanium	For implants Ø 5.0
To be screwed directly onto the implant platform (hex. 2 mm)			

### ● Provisional Abutment



Code	Q.ty	Material	Notes
50160501	1	Titanium	--
To be screwed directly onto the implant platform (hex. 2 mm)			

## 1.7. Components for Impression taking

### ● Impression Post - Analogic



Code	Q.ty	Material	Notes
50050103	3	Titanium	For analogic impression with closed tray
Indicated in all cases of reduced disparallelism between implants and in particularly difficult areas.			

### ● Impression Transfer - Analogic

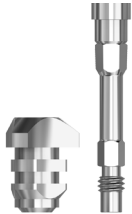

Code	Q.ty	Material	Notes
50051001	1	Titanium	For analogic impression with open tray
Indicated in the case of significant disparallelism between implants.			

### ● Scanbody for digital Impression



Code	Q.ty	Material	Notes
50450001	1	Titanium	For digital impressions with intraoral scanner
To be used on master models with laboratory desktop scanners, it must be mounted on the appropriate implant analog (50304101).			

## 1.8. Surgical and Prosthetic Instruments

### ● Drill Extension



Code	Q.ty	Material	Notes
20070101	1	St. Steel	For drills only. DO NOT use with other tools.

### ● Divergence Pins



Code	Q.ty	Material	Notes
40100102	2	Titanium	To highlight site angle and check parallelism

● Driver, implant Insertion with Handpiece

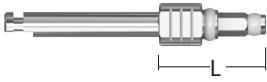

Size	Code	Q.ty	Material	Notes
L = 24.5	40120901	1	St. Steel	Hex. 2 mm
L = 27.5	40121001	1	St. Steel	Hex. 2 mm

For insertion torque NOT exceeding 40/45 Ncm.

● Dynamometric Ratchet



Code	Q.ty	Material	Notes
TR-786-06	1	St. Steel	Adjustable from 20 to 70 Ncm

● Driver with hex. 2 mm for dynamometric ratchet and knob

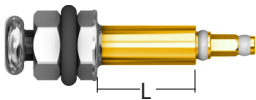

Size	Code	Q.ty	Material	Notes
L = 10	40053501	1	St. Steel	For insertion of Implants 2P - RF - One Stage
L = 16	40053601	1	St. Steel	

● Driver "D-Shape" for dynamometric ratchet and knob

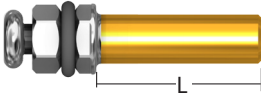

Size	Code	Q.ty	Material	Notes
L = 7	40053201	1	St. Steel	For insertion of Implants QM
L = 17	40053401	1	St. Steel	

● Driver with hex. 1.5 mm for dynamometric ratchet and knob

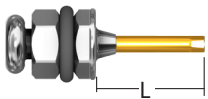

Size	Code	Q.ty	Material	Notes
L = 12	40052901	1	St. Steel	For screwing the short screw supplied with the implant and the healing screws
L = 22	40054501	1	St. Steel	

● Driver with hex. 1.27 mm for dynamometric ratchet and knob

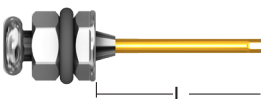

Size	Code	Q.ty	Material	Notes
L = 12	40052701	1	St. Steel	For screwing all screwed abutments.
L = 17	40053101	1	St. Steel	
L = 22	40054401	1	St. Steel	

● Driver with square 2.3 mm for dynamometric ratchet and knob

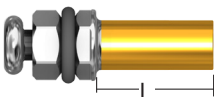

Size	Code	Q.ty	Material	Notes
L = 12	40052601	1	St. Steel	For screwing the provisional abutments.

● Driver with hex. 3.2 mm for dynamometric ratchet and knob

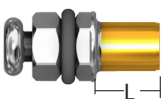

Size	Code	Q.ty	Material	Notes
L = 6	40052401	1	St. Steel	For screwing Easy-On-Four straight abutments.
L = 16	40052501	1	St. Steel	

● Knob for manual screwing

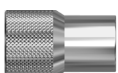

Code	Q.ty	Material	Notes
40052801	1	St. Steel	For manual screwing of the dynamometric ratchet drivers

● Graduated Probe



Code	Q.ty	Material	Notes
40060101	1	Titanium	To measure the implant site depth.

● Implant Pliers



Code	Q.ty	Material	Notes
40070201	1	Titanium	To handle implants after extraction from sterile pack.

● "Bender" tool



Code	Q.ty	Material	Notes
40200101	1	St. Steel	Used to lightly bend the abutment of QM implants.

● Surgical Tray - standard



Size	Code	Q.ty	Material	Notes
190 x 138 x 61 mm	70012101	1	Radel Plastic material	Suitable for sterilization in autoclave cycle B134°C Prions (134°C/2,15 Bar/18 min)

It allows the rational arrangement of the drills and all the surgical instruments. The rationalization of the profiles of the drills and the unification of the implant interfaces allow the use of the same tray for the insertion of the implants "Bone Level" (2P-RF) - "Tissue Level" (One Stage) - Monolithic "QM", simplifying the rationalization of the management processes within the Dental Practice.

## 2 - Laboratory and Prosthetics

### 2.1. "Friction Locking" components for cemented crowns and bridges

#### 2.1.1 Pre-formed Abutments for implants Bone Level "2P" - "RF"

- "Friction Locking" abutments - Non-Rotational - Straight

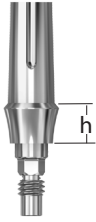

Size	Code	Q.ty	Material	Notes
h=1	50400101	1	Titanium	--
h=2	50400201	1	Titanium	--
h=3	50400301	1	Titanium	--
h=4	50400401	1	Titanium	--

To be screwed directly onto the implant platform (hex. 1.27 mm) to 32 Ncm

- "Friction Locking" abutments - Non-Rotational - Angled 15°



Size	Code	Q.ty	Material	Notes
h=1	50401001	1	Titanium	--
h=2	50401101	1	Titanium	--
h=3	50401201	1	Titanium	--
h=4	50401301	1	Titanium	--

To be screwed directly onto the implant platform (hex. 1.27 mm) to 32 Ncm

- "Friction Locking" abutments - Non-Rotational - Angled 30°



Size	Code	Q.ty	Material	Notes
h=1	50402001	1	Titanium	--
h=2	50402101	1	Titanium	--
h=3	50402201	1	Titanium	--
h=4	50402301	1	Titanium	--

To be screwed directly onto the implant platform (hex. 1.27 mm) to 32 Ncm

#### 2.1.2 Pre-formed Abutments for implants Tissue Level "One Stage"

- "Friction Locking" abutments - Non-Rotational - Straight



Size	Code	Q.ty	Material	Notes
--	50500201	1	Titanium	--

To be screwed directly onto the implant platform (hex. 1.27 mm) to 32 Ncm

- "Friction Locking" abutments - Rotational - Straight



Size	Code	Q.ty	Material	Notes
--	50500101	1	Titanium	--

To be screwed directly on the implant shoulder (Driver "D-Shape) to 32 Ncm

- "Friction Locking" abutments - Non-Rotational - Angled 15°



Size	Code	Q.ty	Material	Notes
--	50500301	1	Titanium	--

To be screwed directly on the implant shoulder (hex. 1.27 mm) to 32 Ncm



## 2.2.2 Components for customized CAD / CAM abutments

### ● Premilled "Friction Locking" – Medentikaa



Size	Code	Q.ty	Material	Notes
Plat. Ø 3.5	50462501	1	Titanium	--
Plat. Ø 4.1	50462701	1	Titanium	--
Plat. Ø 5.0	50462801	1	Titanium	--

For the preparation of anatomical and customized abutments made in CAD / CAM for "Bone Level" implants.  
To be screwed directly onto the implant platform (hex. 1.27 mm) to 32 Ncm

## 2.2. "Friction Locking" components for screwed crowns and bridges

### 2.2.1 Link (Ti Base) for CAD / CAM processing

#### ● Link "Friction Locking" – Non Rotational



Size	Code	Q.ty	Material	Notes
Plat. Ø 3.5	50451001	1	Titanium	--
Plat. Ø 4.1	50451201	1	Titanium	--

To be screwed directly onto the implant platform (hex. 1.27 mm) to 32 Ncm

#### ● Link "Friction Locking" – Rotational

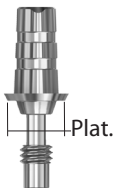

Size	Code	Q.ty	Material	Notes
Plat. Ø 3.5	50452101	1	Titanium	--
Plat. Ø 4.1	50452301	1	Titanium	--

To be screwed directly onto the implant platform (hex. 1.27 mm) to 32 Ncm

## 2.3. Laboratory tools and materials for "Friction Locking"

### 2.3.1 Components for master model (analogic)

#### ● Laboratory analogues



Code	Q.ty	Material	Notes
50304101	1	Titanium	For implants Bone Level "2P" e "RF"
50304201	1	Titanium	For implants Tissue Level "One Stage"

To reproduce the implant in traditional analogic or stereolithographic models.

#### ● Scanbody for Digital Impression

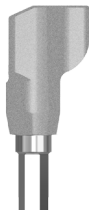

Code	Q.ty	Material	Notes
50450001	1	Titanium	For digital impression on analogic model

It must be mounted on the special implant analog 50304101, inserted in the traditional or stereolithographic models.

### 2.3.3 "Friction Locking" abutment selection tools

#### ● Misalignment Meters



Code	Q.ty	Material	Notes
40100201	1	Titanium	For traditional or stereolithographic models.

They display the disparallelism angle of the implants.

#### ● Gum Meters

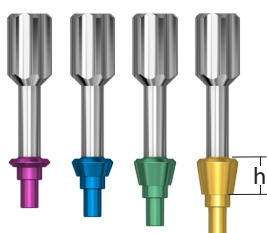

Size	Code	Q.ty	Material	Notes
h=1	40110101	1	Titanium	Purple
h=2	40110201	1	Titanium	Blue
h=3	40110301	1	Titanium	Green
h=4	40110401	1	Titanium	Yellow
--	40110501	1	Titanium	Kit of gum meters - Includes 4 meters

For traditional analogic or stereolithographic models. They allow the evaluation of the height of the soft tissue, before selecting the abutments.

### 2.3.2 Tools for screwing abutments "Friction Locking"

#### ● Knob for manual screwing

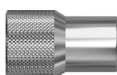

Code	Q.ty	Material	Notes
40052801	1	St. Steel	For manual screwing of the drivers

#### ● Driver with hex. 1.27 mm for dynamometric ratchet and knob

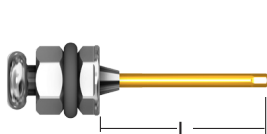

Size	Code	Q.ty	Material	Notes
L = 12	40052701	1	St. Steel	For screwing all screwed abutments.
L = 17	40053101	1	St. Steel	
L = 22	40054401	1	St. Steel	

## 2.4. Components for prosthesis "Easy-On-Four"

### 2.4.1 Abutment "Easy-On-Four" (MUA)

#### ● Abutments Easy-On-Four (MUA) – Straight



Size	Code	Q.ty	Material	Notes
h=1	50300101	1	Titanium	--
h=2	50300201	1	Titanium	--
h=3	50300301	1	Titanium	--
h=4	50300401	1	Titanium	--

To be screwed directly onto the implant platform (hex. 3,2 mm) to 32 Ncm

#### ● Abutments Easy-On-Four (MUA) - Angled 17°



Size	Code	Q.ty	Material	Notes
h=3	50301001	1	Titanium	--
h=4.5	50301101	1	Titanium	--

To be screwed directly onto the implant platform (hex. 1.27 mm) to 32 Ncm

#### ● Abutments Easy-On-Four (MUA) - Angled 30°



Size	Code	Q.ty	Material	Notes
h=3	50301201	1	Titanium	--
h=4.5	50301301	1	Titanium	--

To be screwed directly onto the implant platform (hex. 1.27 mm) to 32 Ncm

#### ● Healing Caps (4 pcs)



Code	Q.ty	Material	Notes
50045004	4	Peek	--

To be screwed through the screw 50302004 to all abutments after surgery, to cover the emergence profile during the healing period of the soft tissues.

#### ● Abutment Positioner



Code	Q.ty	Material	Notes
40200201	1	Titanium	It facilitates the positioning and orientation of the abutments.

To be screwed by 1.27mm hex driver.

#### ● Prosthetic Screws (4 pcs)



Code	Q.ty	Material	Notes
50302004	4	Titanium	For screwing prosthetic components to all abutments.

To be screwed by 1.27mm hex driver.

### 2.4.2 Impression taking and model development

#### ● Analogic Impression Transfer

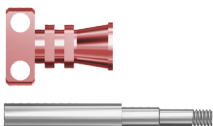

Code	Q.ty	Material	Notes
50303001	1	Titanium	For analogic impression with closed tray

To be screwed by 1.27mm hex driver.

● Scanbody

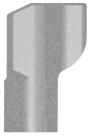

Code	Q.ty	Material	Notes
50451401	1	Titanium	For digital impressions with intraoral or desktop scanners
Complete with fixing screw. For use on models with laboratory desktop scanners, it must be fitted to the proper implant analog (50304001).			

● Laboratory analog



Code	Q.ty	Material	Notes
50304001	1	Titanium	Reproduces the emergence profile of all Easy-on-Four® abutments.
For traditional analogic and stereolithographic models.			

**2.4.3 Components for the development of the "Easy-On-Four" prosthesis**

● Waxing Screw



Code	Q.ty	Material	Notes
50302204	4	St. Steel	To keep the passage of the fixing screws open.
To be screwed by 1.27 mm hex driver.			

● Titanium Caps



Code	Q.ty	Material	Notes
50170302	2	Titanium	Rotational for bridges.
50170402	2	Titanium	Non-rotational for single elements.
For the realization of the prosthesis or for structures to be applied with the bonding technique.			

● Burnout Caps



Code	Q.ty	Material	Notes
50044104	4	Methacrylate	Rotational for bridges.
50044204	4	Methacrylate	Non-rotational for single elements.
For the realization of cast structures.			

● Burnout Spacers



Code	Q.ty	Material	Notes
50045104	4	Methacrylate	---
To ensure sufficient space to achieve passivity with the bonding technique.			

**2.4.4 "Easy-On-Four" abutment screwing instruments**

● Driver with hex. 3.2 mm for dynamometric ratchet and knob

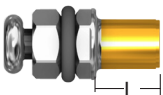

Size	Code	Q.ty	Material	Notes
L = 6	40052401	1	St. Steel	For screwing straight Easy-On-Four abutments
L = 16	40052501	1	St. Steel	

● Driver with hex. 1.27 mm for dynamometric ratchet and knob

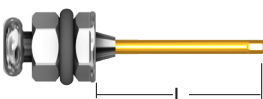

Size	Code	Q.ty	Material	Notes
L = 12	40052701	1	St. Steel	For screwing all Easy-On-Four abutments angled 17 ° and 30 °.
L = 17	40053101	1	St. Steel	
L = 22	40054401	1	St. Steel	

### 3.1. Handling and insertion of the implants

#### 3.1.1 Packaging and Labeling

All Bone System implants are enclosed in a box, the seal label shows all the identification data of the product and the expiry date.

The opening of the sterile blister, contained inside the box, must be carried out only at the time of insertion of the implant and the normal rules of asepsis must be observed when handling the contents.

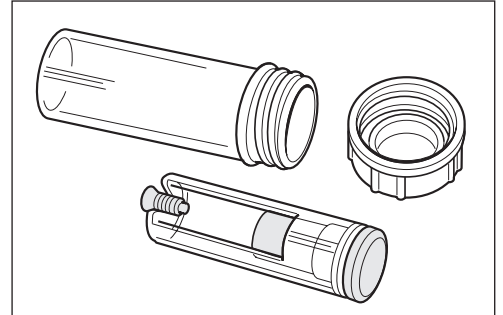

#### 3.1.2 Picking and insertion of "2P" - "RF" - "One Stage" implants

- The insertion of the implant at a controlled torque (max 50 Ncm) is performed:
  - by means of special 2 mm hexagonal drivers, mounted on a contra-angle handpiece operated by a micromotor, at a speed of 20/25 rpm,
  - by means of a dynamometric ratchet and 2 mm hexagonal driver.

**IMPORTANT** - Excessive torque (over 50 Ncm) applied during insertion, can create excessive stress on the bone and damage the hex. inside the implant.

- Manual insertion is done through a knob to which the 2 mm hexagonal driver is applied.

#### ● With Micromotor

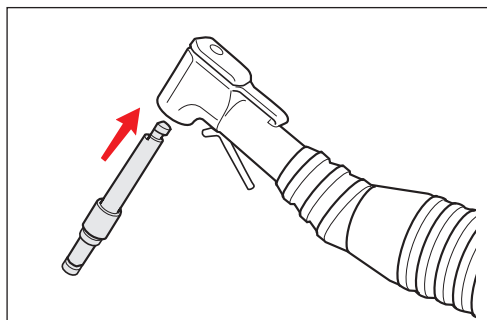

**1.**  
Insert the 2 mm hexagonal driver into the instrument.

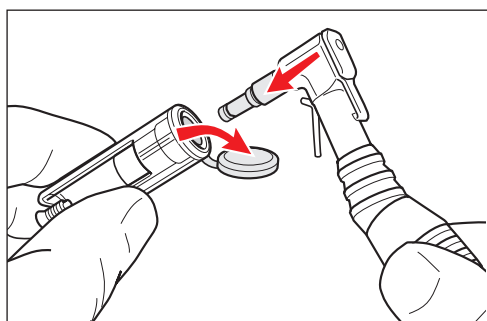

**2.**  
Open the container and insert the driver into the hexagon inside the implant.

#### ● With dynamometer Ratchet

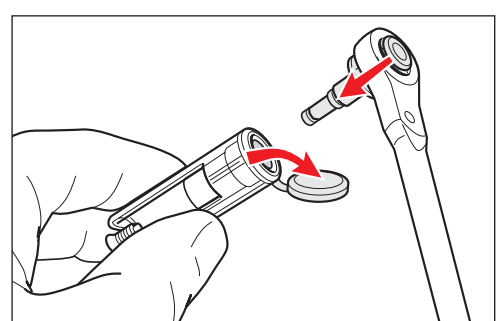
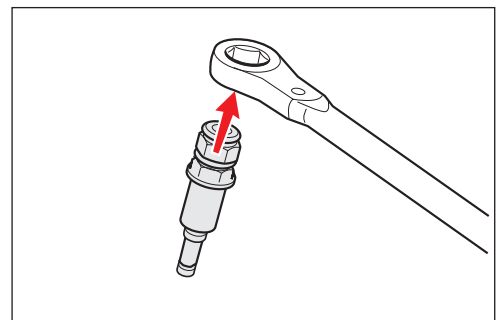

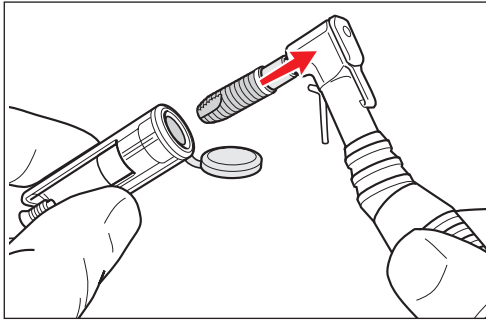

**3.**  
Extract the implant inserted in the driver.

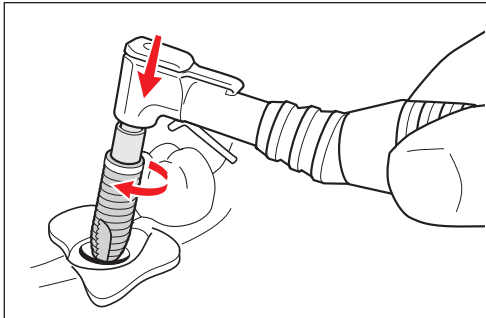
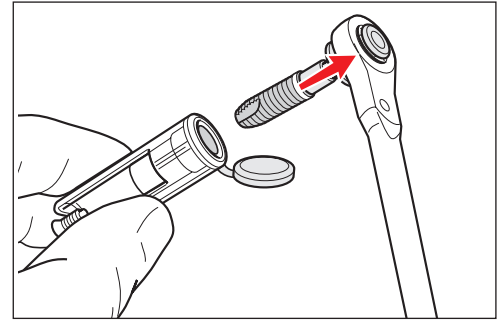

**4.**  
Insert and screw the implant into the implant site.

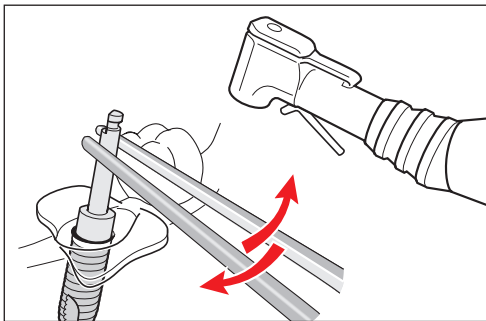
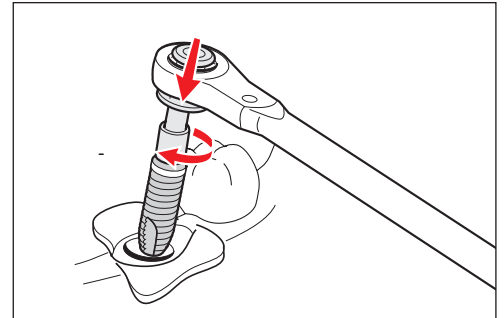

**5.**  
Remove the driver at the end of the insertion.

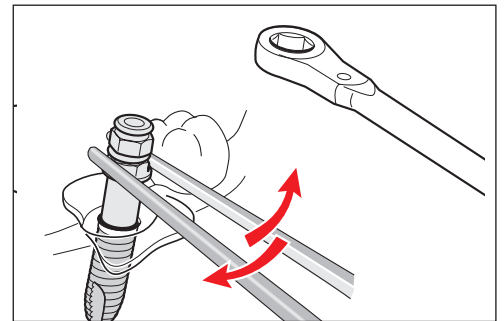

**NOTE** - If the driver remains inserted in the implant, it is sufficient to grasp it with tweezers and extract it by applying light rotational movements to free the hexagon

### 3.1.3 Closure of "2P" - "RF" - "One Stage" implants

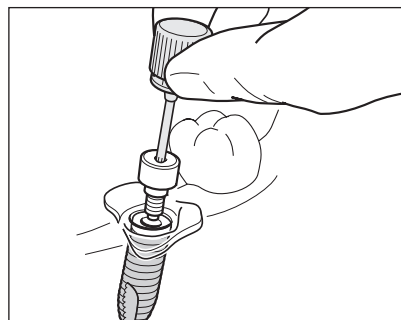
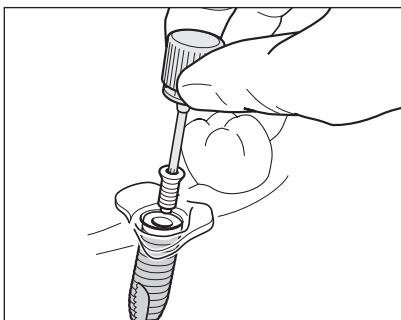

● "2P" - "RF":  
Close the implant with the short screw for a submerged technique, or close with the healing screw for a non-submerged technique.

● "One Stage" only with transmucosal technique:  
Close the implant with a short screw.

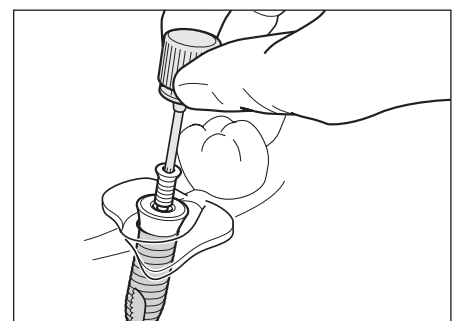

### 3.1.4 Prelievo e inserimento degli impianti "QM" - Quick Mounted

- The insertion of the implant at a controlled torque (max 50 Ncm) is performed:
  - by means of special "D-Shape" driver, mounted on a contra-angle handpiece operated by a micromotor, at a speed of 20/25 rpm,
  - by means of a dynamometric ratchet and "D-Shape" driver.

**IMPORTANT** - Excessive torque (over 50 Ncm) applied during insertion, can create excessive stress on the bone.

- Manual insertion is done directly with the use of the implant holder, or through a knob in which the "D-Shape" driver is applied.

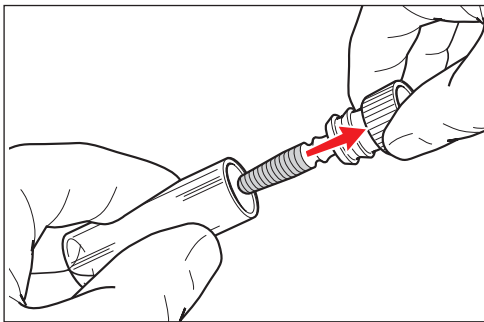
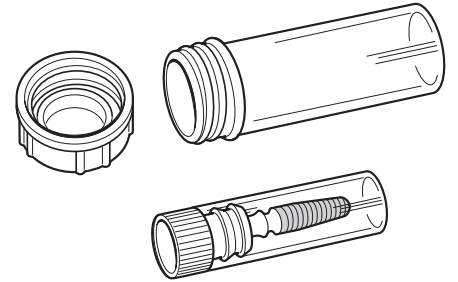

1. Open the internal container and remove the implant by means of the retentive implant holder.

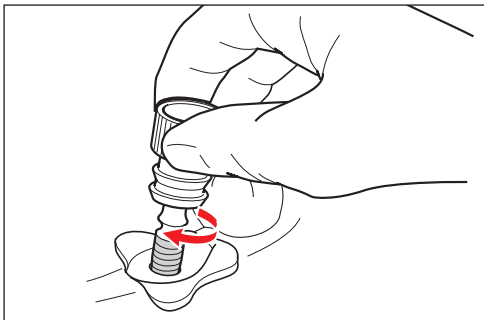

2. Insert the implant into the implant site and perform a preliminary screwing, using the implant holder.

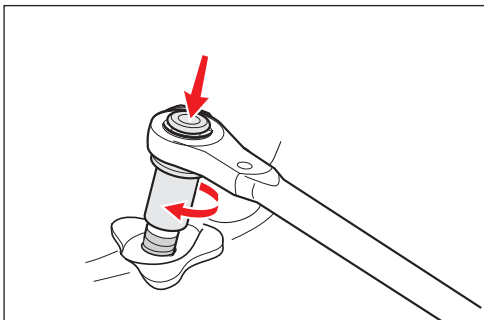

3. Perform the final tightening at controlled torque using the "D-Shape" driver and the dynamometric ratchet.

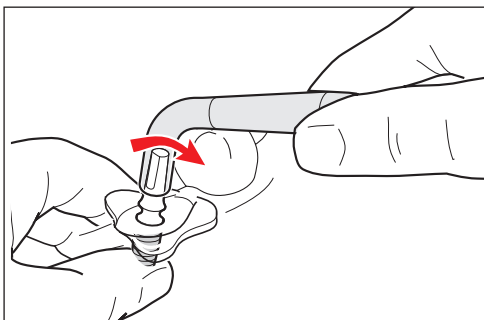

4. Possible correction of the disparallelism with the bending of the implant neck using the "Bender" instrument.

**IMPORTANT** - This operation can only be performed with  $\varnothing$  2.8 and 3.5 mm implants, avoiding repeated movements and implementing all the necessary precautions to avoid fracture of bone segments.

### 4.1. Temporary Elements

#### 4.1.1 Stages of use of Temporary Abutments

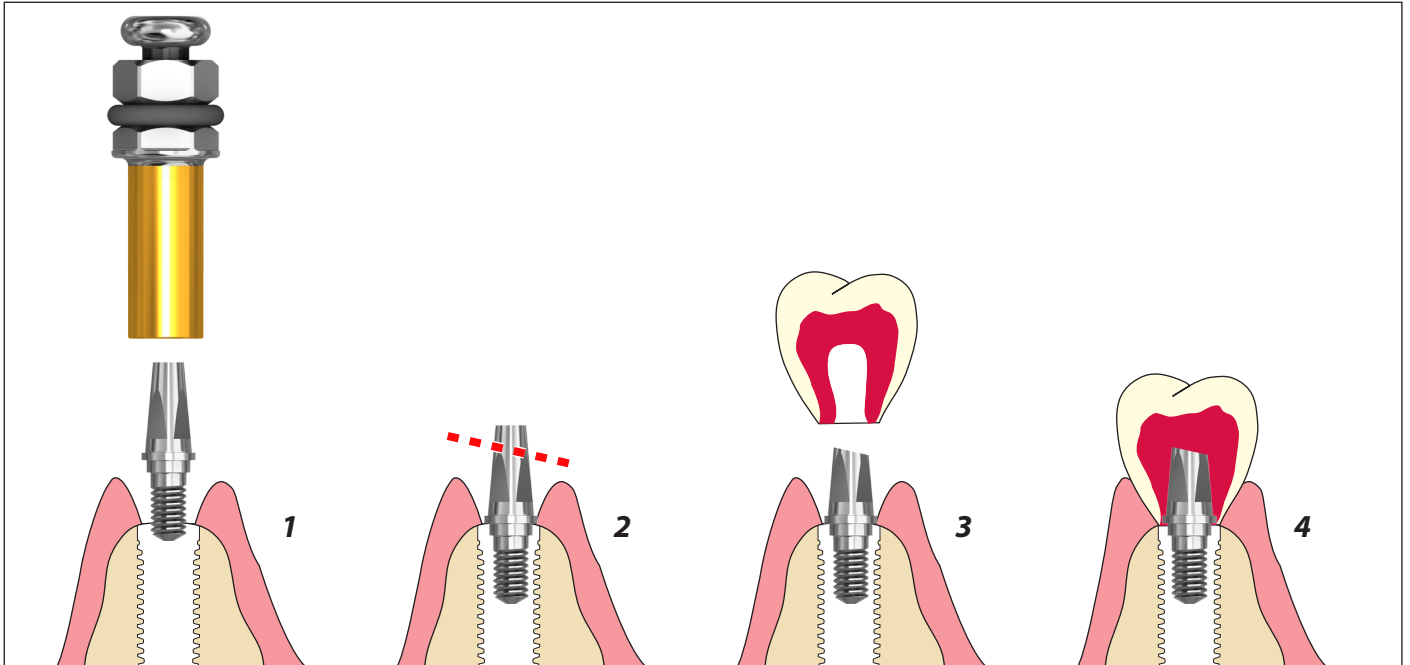

1. Screw the abutment using the 2.3 square driver with a maximum torque of 32 Ncm.
2. Modify the emergence profile of the abutment to adapt it to the clinical situation, using adequate tools and under abundant irrigation, taking care not to damage the screwing square portion. With the 2.3 square driver restore the correct screwing to a maximum torque of 32 Ncm.
3. Fill with resin the previously prepared shelled provisional prosthesis and apply it to the abutments to perform the relining.
4. After the resin has hardened, cement the provisional prosthesis with temporary cement, according to customs, carefully removing the excess cement.



## 4.2. Taking the impression

### 4.2.1 Indirect analogic Workflow (tear-off post)

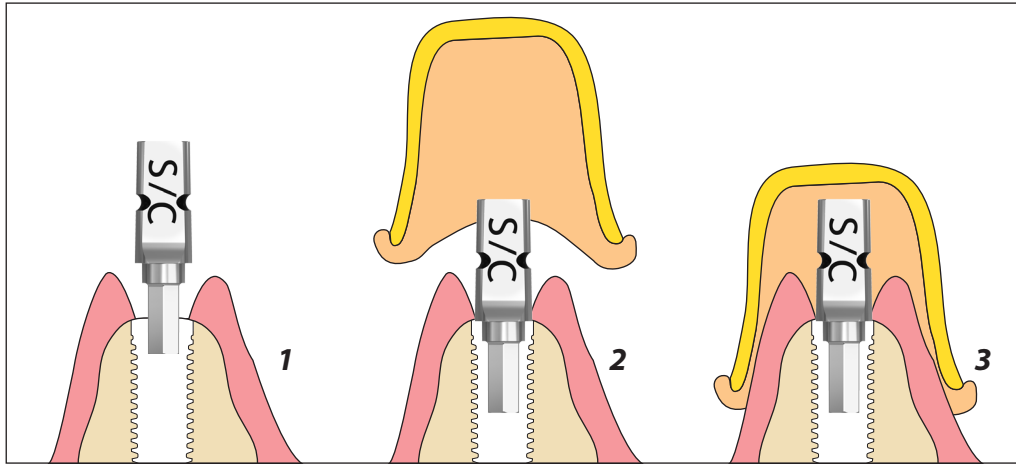

**NOTE** - This technique with closed tray for taking the impression is applicable in all situations with reduced dis-parallelism between the implants.

1. Insert the hexagonal stem of the impression post into the internal hexagonal cavity of the implant and push it fully until the abutment base fits perfectly with the surface of the implant platform.

**NOTE** - The hexagonal end of the impression post can be activated, in order to ensure maximum stability during subsequent maneuvers.

2. Fill the tray with the impression material, insert it into the mouth and exert regular pressure, gradually removing the excess material.

3. When the impression material has hardened, extract the tray, paying the utmost attention not to damage the impression.

**NOTE** - When the tray with impression is extracted, the posts can remain embedded in the impression, or remain inserted in the implants; this occurs in a non-predetermined way, according to the type and hardness of the material used, the degree of disparallelism, the extraction method, etc., without prejudice to the success of the operation.

#### 4.2.2 Direct analogic Workflow (screwed transfer)

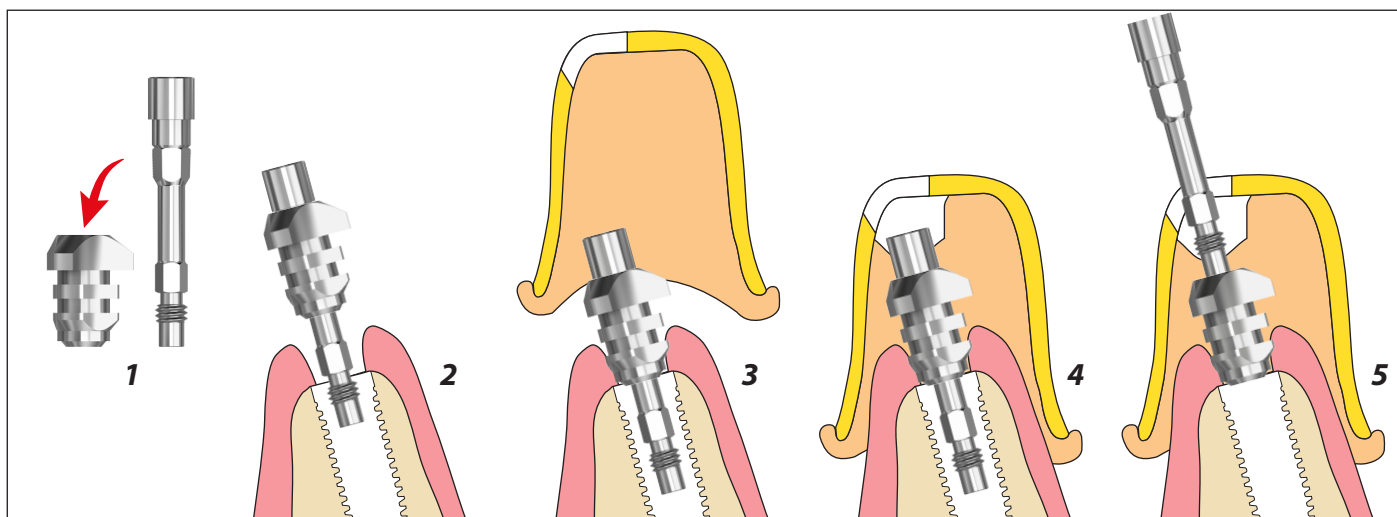

**NOTE** - This technique for taking the impression, with the tray partially open, is applicable in all situations in which the significant disparallelism between the implants would not allow the indirect technique.

1. Prepare the impression post by inserting the pin into the transfer, making sure the hexagon is correctly coupled inside of the transfer with the corresponding hexagon of the pin.
2. Fully screw the pin into the internal thread of the implant, until the base of the transfer fits perfectly with the surface of the implant platform.
3. Prepare the tray with the holes for accessing the pins and fill it with the impression material, then insert the tray into the oral cavity and exert regular pressure, gradually removing the excess material.
4. **Important** - Always make sure to maintain access to the locking pin.
5. When the material has hardened, completely unscrew and remove the pin from the transfer, then extract the tray, paying the utmost attention not to damage the impression.

### 4.2.3 Digital Workflow with intraoral Scanner

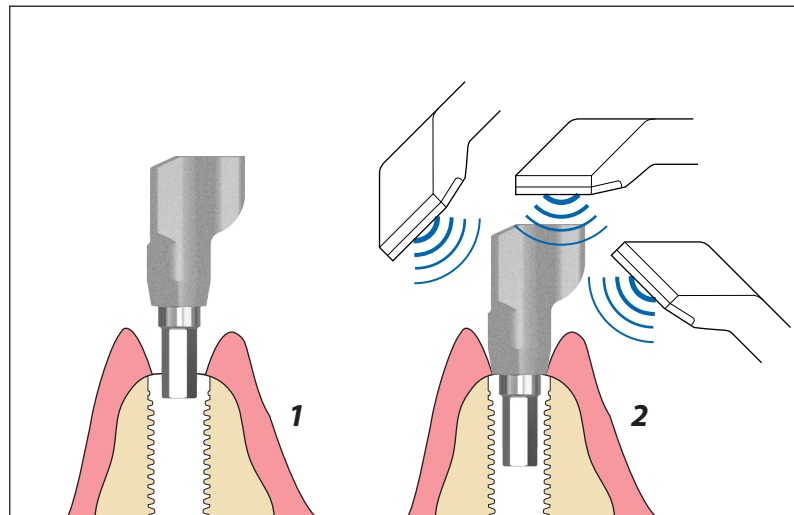

1. Insert the hexagonal end of the scanbody into the internal hexagonal cavity of the implant and push it thoroughly to the **perfect matching** of the base of the scanbody with the surface of the implant platform.

**NOTE** - The particular morphology of the scanbody has been expressly designed to ensure maximum precision in the phase of overlapping (matching) of the data; therefore it is always advisable to expose the flat surfaces in a vestibular sense, in order to facilitate the scanning of the planes by the scanner.

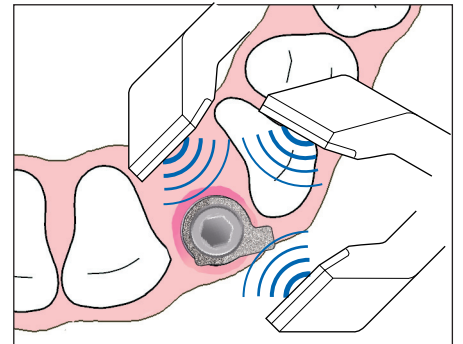

2. Activate the intraoral scanner and move the handpiece along the entire affected area, with a continuous movement that embraces the vestibular side, the occlusal surface and the lingual / palatal side, following the Manufacturer's recommendations.

#### 4.2.4 Digital Workflow with desktop Scanner

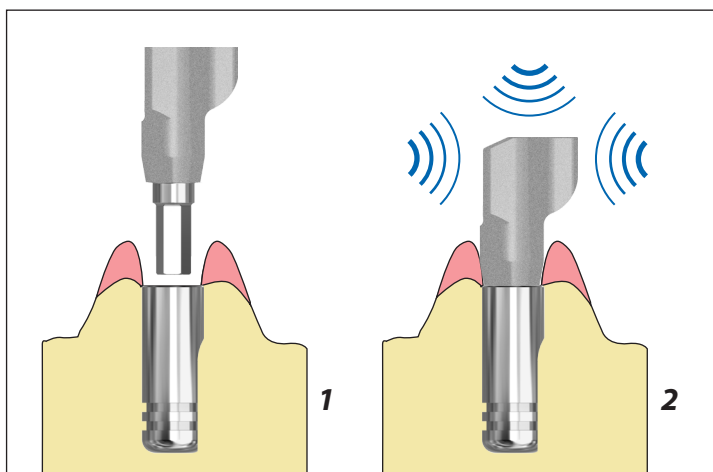

**NOTE** - This digital technique is feasible both with stone and stereolithographic models, in which the implant analogues have been inserted.

1. Insert the hexagonal end of the scanbody into the internal hexagonal cavity of the implant analog and push it thoroughly to the **perfect matching** of the base of the scanbody with the surface of the analog platform.

**NOTE** - The particular morphology of the scanbody has been expressly designed to ensure maximum precision in the phase of overlapping (matching) of the data; therefore it is always advisable to expose the flat surfaces in a vestibular sense, in order to facilitate the scanning of the planes by the scanner.

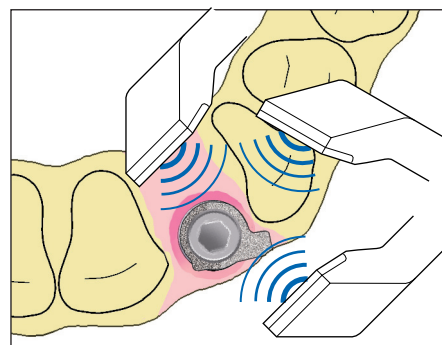

2. Activate the desktop scanner and scan the model, following the Manufacturer's recommendations.

### 4.3. The Bone System Screwed Connections

#### 4.3.1 Features and Specificities of Bone System Screwed Connections

The repositionable screwed abutments "Friction Locking" adopt an exclusive connection system to the implant capable of counteracting its loosening, as well as allowing absolute stability and absence of micro-movements with respect to the implant, hitherto unthinkable in other implant connections.

The tests carried out show that the "Friction Locking" connection allows to obtain an abutment that supports loads three times higher than the most qualified competitors, this is because the technique of joining the components and the maximum respect of the machining tolerances makes it possible to transfer loads over a large surface, preserving the stem of the fixing screw from the stresses deriving from lateral loads.

The "Friction Locking" connection is therefore a guarantee for users and patients.

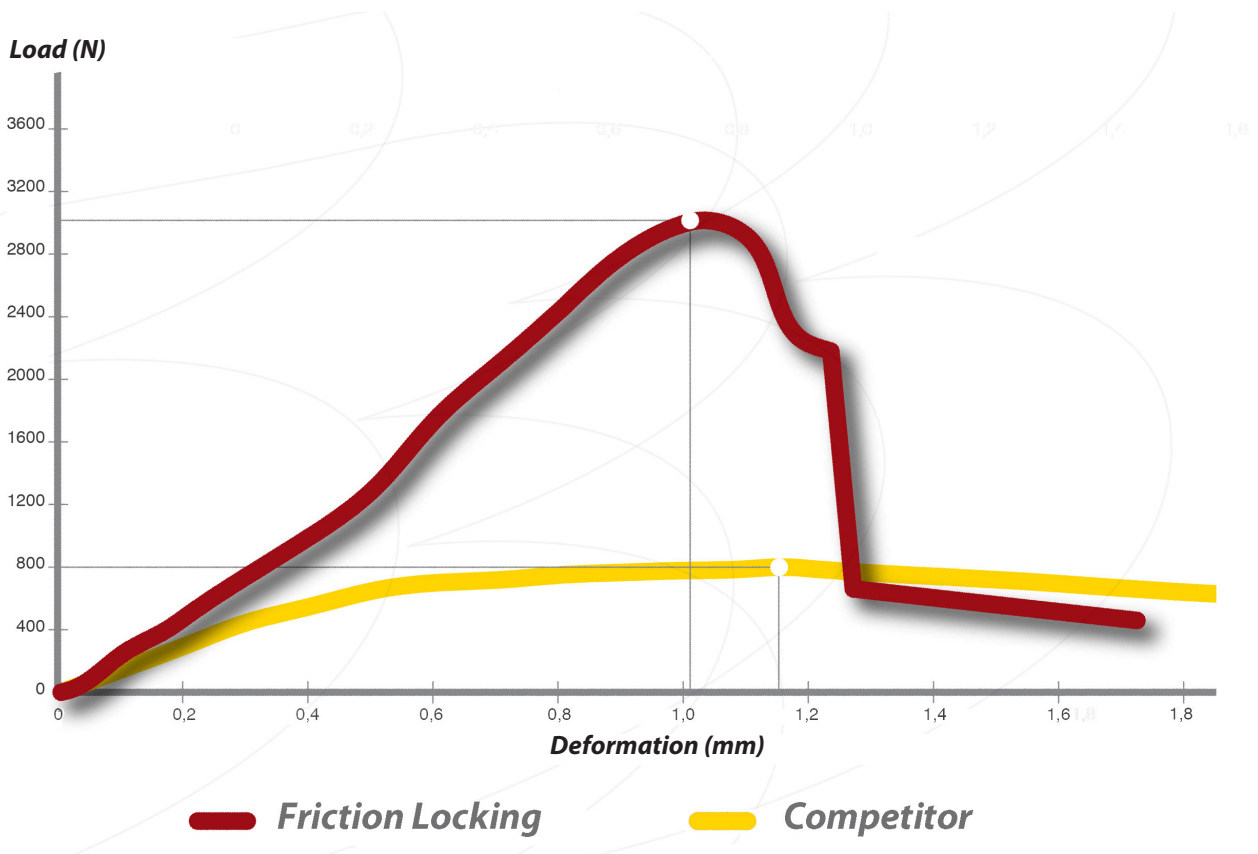
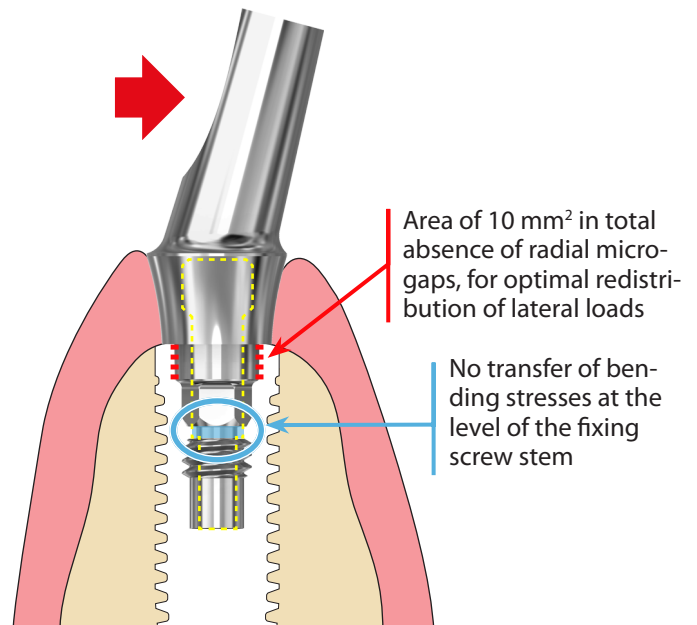

The tests carried out have shown that the abutment "Friction Locking" is able to support loads up to three times higher than the ones of most qualified competitors.

### 4.3.2 Screwing Mode

The specificity of the "Friction Locking" abutments is given by the fixing screw integrated in the abutment and in a fit with a slight interference (friction) of the cylindrical part inside the system.

To fully benefit from the advantages of this particular fitting, it is necessary to proceed with the screwing with some precautions, acting as follows.

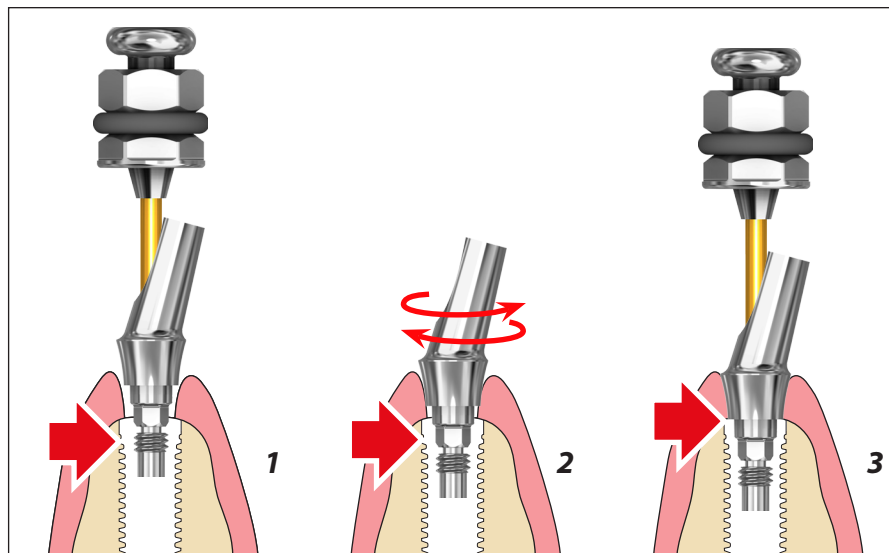

1. Insert the abutment into the implant and start screwing until you feel the impact of the two hexagons, then loosen the grip of the screw (1) unscrewing by about half a turn.
2. Slightly rotate the abutment in both directions until the hexagons are correctly taken in the optimal position provided for the correction of dysparallelism.
3. Continue screwing until an increase in torque is felt due to the friction interface of the abutment with respect to the implant seat, then complete the screwing in fully with the dynamometric instrument, applying a maximum torque of 32 Ncm until complete descent of the abutment.

**IMPORTANT** - Always check the complete descent of the abutment by means of an intraoral x-ray.

## 4.4. Bridges and Crowns cemented on "Friction Locking" Abutment

**NOTE** - The versatility of the system allows a wide variety of solutions and different combinations between traditional and digital methods, as well as the preparation of the abutment directly in the patient's mouth.

### 4.4.1 Selection criteria for "Friction Locking" abutments

The "Friction Locking" abutments are available with different angles to compensate for the disparallelisms between the implants, as well as in different heights of the transmucosal path to adapt to the thickness of the patient's soft tissues.

Therefore, the choice of the correct abutment is an essential element to achieve the maximum result from the rehabilitation, in terms of functionality and aesthetics; for this purpose, two evaluation kits are provided.

#### a) Gum meters

Kit consists of four meters, with the simulation of four different heights of the transmucosal path. Inserted in the implant, they allow the visual evaluation of the most suitable height to obtain the ideal prosthetic margin of the prosthesis.

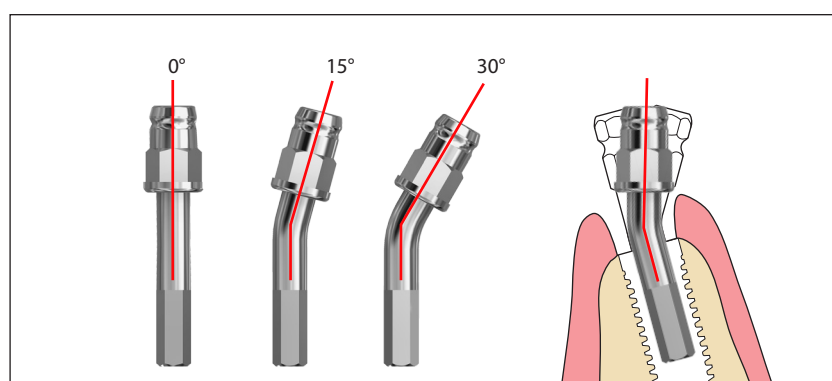
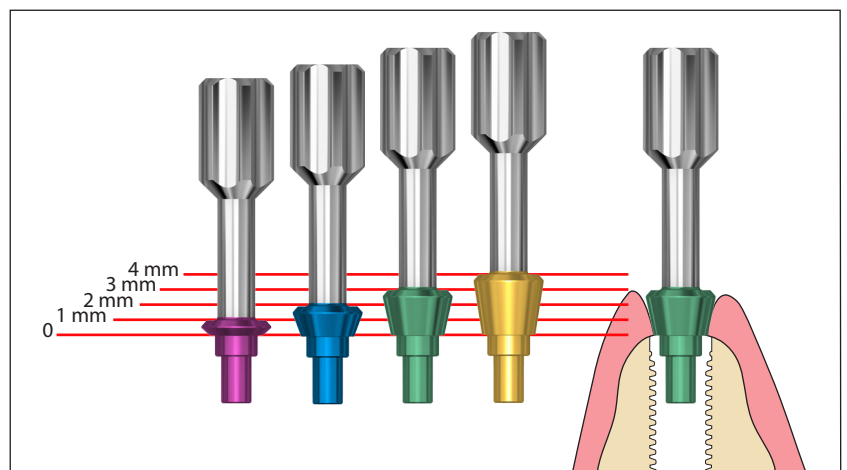

#### b) Misalignment meters

Kit consists of three meters, with the simulation of the three different angles of the abutment emergence profile. Inserted in the implant, they allow the visual evaluation of the most suitable angle to obtain the correct parallelism.

#### 4.4.2 Preparation of the abutment in the laboratory

**NOTE** - This technique is applicable both with straight abutments and with abutments inclined at 15 ° and 30 °.

– Take a traditional or digital impression. [see 4.2]

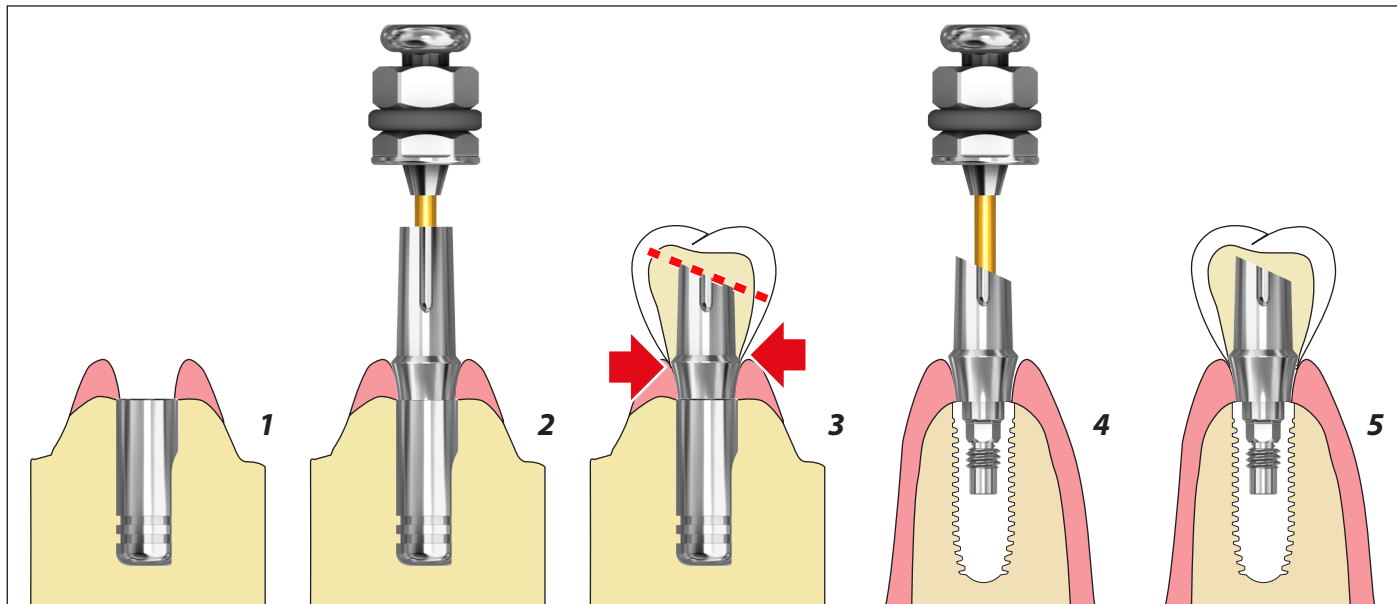

1. On the basis of the impression, the dental laboratory can obtain the stone or stereolithographic master model, in which the analogues of the implants are placed.

2. Select the appropriate abutment for the case, according to the thickness of the soft tissues and the disparallelism to be corrected [see 5.1.1] and screw the abutment with the 1.27 mm hexagonal driver.

**NOTE** - The analogue of the implant is equipped with a non-friction connection and therefore does not require special precautions to be adopted for screwing.

3. Modify the emergence profile of the abutment with the proper tools for titanium, so as to bring it in parallel and adapt it to clinical needs. Proceed with the modeling and finishing of the metals and ceramics, according to the usual techniques, seeking the closure of the prosthetic margin along the perimeter of the transgingival path of the abutment.

4. Once all the aesthetic and functional tests have been carried out, fully screw the abutment to the implant according to the procedures indicated [see 4.3.2]; then verify the complete descent with an intraoral x-ray.

5. Cement the structure on the emergence profile of the abutment, according to the customs of the Dental Practice.

#### 4.4.3 Preparation of abutment in the mouth

The abutment "Friction Locking" can be screwed deeply and then prepared directly by the doctor, in the patient's mouth according to the procedure indicated above, which can be followed up with an impression as in the case of a natural tooth.



#### 4.4.4 Digital Workflow in CAD/CAM

**NOTE** - This technique allows to create abutments and complex structures with a high level of customization in terms of inclination, height and optimal festooning of the prosthetic margins for the cementation of the crown, in order to obtain rehabilitations with high aesthetic value.

- Take a digital impression with intraoral scanner. [see 4.2]

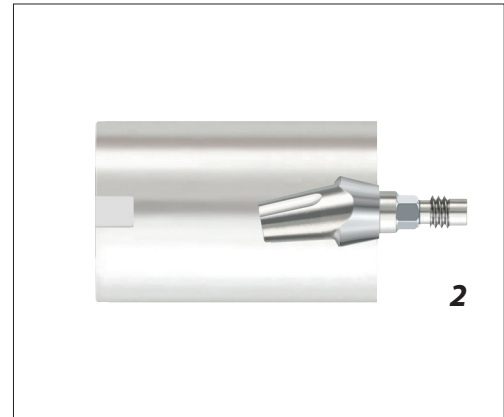
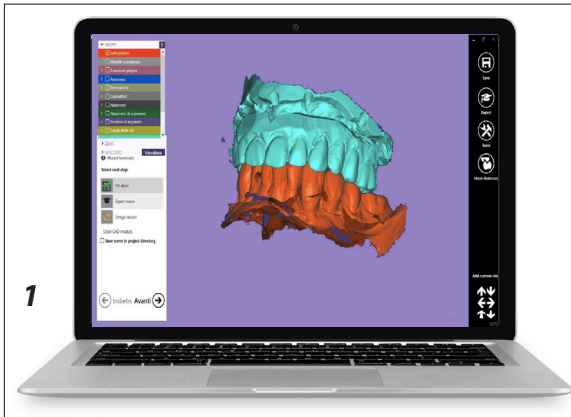

1. Through the computerized 3D design with dedicated software, proceed with the design of the morphology of the abutment with customization of the prosthetic margin and of the repositioning and retention elements of the structure.

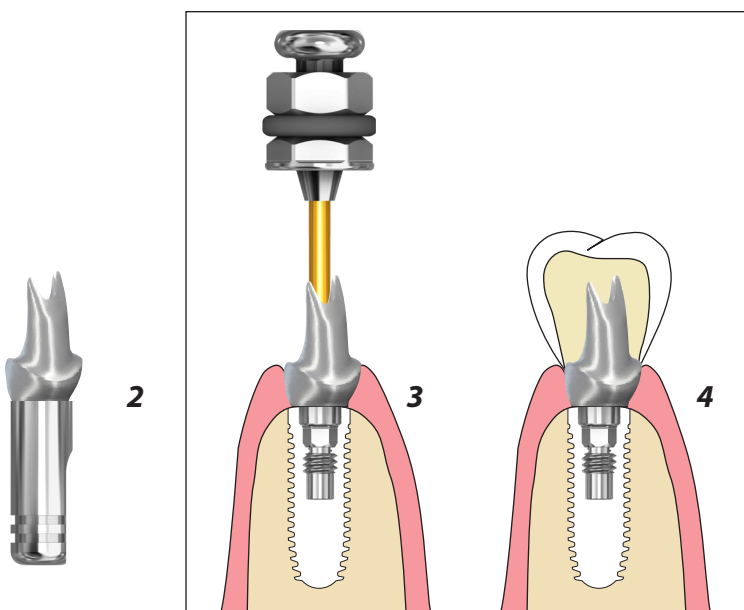

2. Send the STL file to a Milling Center and proceed to the CAM machining of the premilled "Friction Locking".
3. Once all the aesthetic and functional tests have been carried out, fully screw the abutment to the implant according to the procedures indicated [see 4.3.2]; then verify the complete descent with an intraoral x-ray.
4. Cement the structure on the emergence profile of the abutment, according to the customs of the Dental Practice.

## 4.5. Single Crowns and Bridges screwed on "Friction Locking" Links

**NOTE** - This technique implies that the single crown or complex structures are cemented on one or more posts (defined as "Link" or "TiBase"), in turn screwed to the implants.

**NOTE** - The Bone System links adopt the same "Friction Locking" connection principle, that ensures a very high resistance to lateral loads, does not concentrate the stresses on the fixing screw to the implant and counteracts the possibility of loosening the screw itself. [see 4.3.1]

### 4.5.1 General Informations

The Bone System Link essentially consists of a base and a truncated cone emergence profile, which can be shortened to adapt to the available height and is characterized by a repositioning cam.

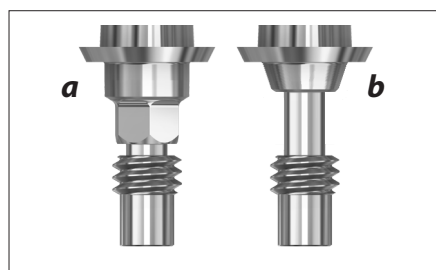
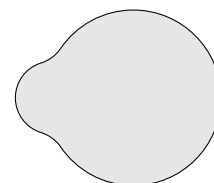

The base of the link is available for two different implant platforms, each of which can be

- anti-rotational for single crowns (a),
- rotational for bridges or complex structures (b).

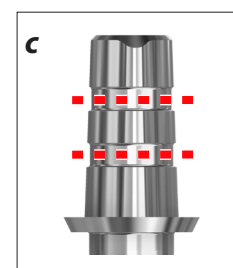

The emerging part has two grooves (c) that define the two points provided for a possible shortening, inserted in the 3D models of the design CAD software library.

The use of links requires an exclusively digital design approach with which, starting from the morphology of the emergence profile, it is possible to design and build the prosthetic elements with the most suitable materials for the type of reconstruction required, such as, for example, zirconia abutment, zirconia crowns, etc.

### 4.5.2 Digital Workflow CAD/CAM

- Take a traditional or digital impression with intraoral scanner. [see 4.2] In the case of a traditional impression, a model should be developed in which implant analogues are placed and then scanned with a laboratory desktop scanner.
- Through the computerized design in 3D with dedicated software, proceed to the design and modeling of the morphology of the single crown, zirconia abutment or structure, defining the type of link to be used and the height of the emergence profile according to the available space.

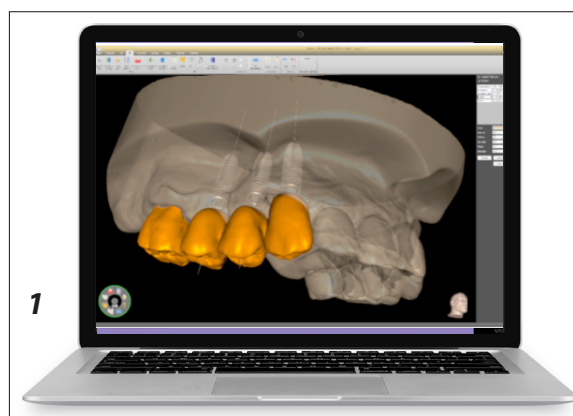

### a) Processing steps for single crown or bridge

1. Adapt the height of the link, cutting of, if necessary, the excess part as defined in the design phase.
2. Cement the crown on the link.

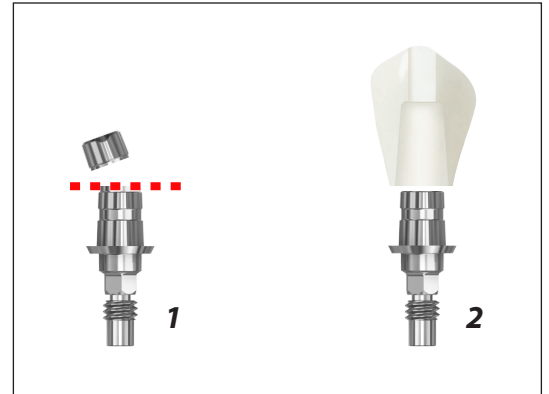

### b) Processing steps for single crown or bridge with zirconia abutments

1. Adapt the height of the link, cutting of, if necessary, the excess part as defined in the design phase.
2. Cement the zirconia abutment on the link.
3. Cement the crown on the zirconia abutment, keeping the access to the fixing screw perVIOUS.

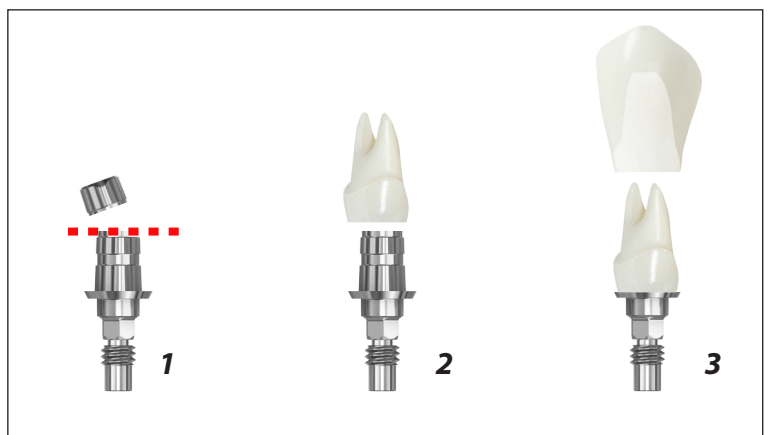

### 4.5.3 Screwing the link to the implant

After carrying out all the aesthetic and functional tests, screw the link/crown assembly to the implant thoroughly according to the procedures indicated [see 4.3.2]; then check the complete descent with an intraoral RX.

Protect the hexagonal site of the screw, then fill the passage of the screw with composite and finish the surfaces according to the customs of the Dental Practice.

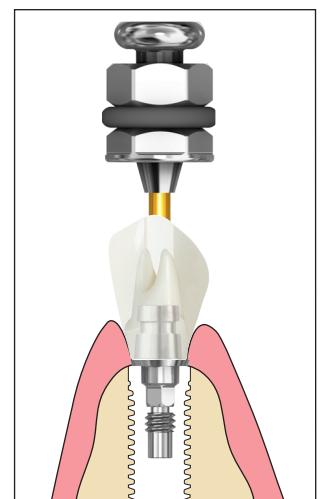

## 4.6. Prosthetic procedure "Easy-On-Four"

**Introduction** - This implant rehabilitation technique was proposed by Dr. Paulo Malò; his first work setting the protocol was published in 2003 with the definition of "All on Four/Six".

The key feature of this technique consists in restoring an entire arch only on 4 or 6 implants, some of which are inclined to make the most of all the available bone.

With inclined implants it is possible to avoid additional surgical techniques to avoid the emergence of the inferior alveolar nerve or to raise the maxillary sinus floor.

Finally, this technique allows rehabilitation with a reduced number of implants, obtaining a substantial reduction in costs, for the benefit of patients with severe atrophy.

**NOTE** - The Bone System "Easy-On-Four" abutments use the same "Friction Locking" connection principle which ensures a very high resistance to lateral loads, does not concentrate the stresses on the fixing screw to the implant and counteracts the possibility of loosening of the screw itself [see 4.3.1].

### 4.6.1 Selection criteria for "Easy-On-Four" abutments

The "Easy-On-Four" abutments (commonly defined as MUA) are available with different angles to compensate for the inclination of the implants, as well as at different heights of the transmucosal path to adapt to the thickness of the patient's soft tissues.

The choice of the correct abutment is therefore an essential element to achieve the maximum result from rehabilitation, in terms of functionality and aesthetics; for this purpose, two evaluation kits are provided, the use of which is described in point 5.1.1 of this manual.

Select the "Easy-on-four" abutments according to the dysparallelism to be corrected. Take into account that the morphology of the emergence profile of abutments allows to correct dysparallelisms up to 45°.

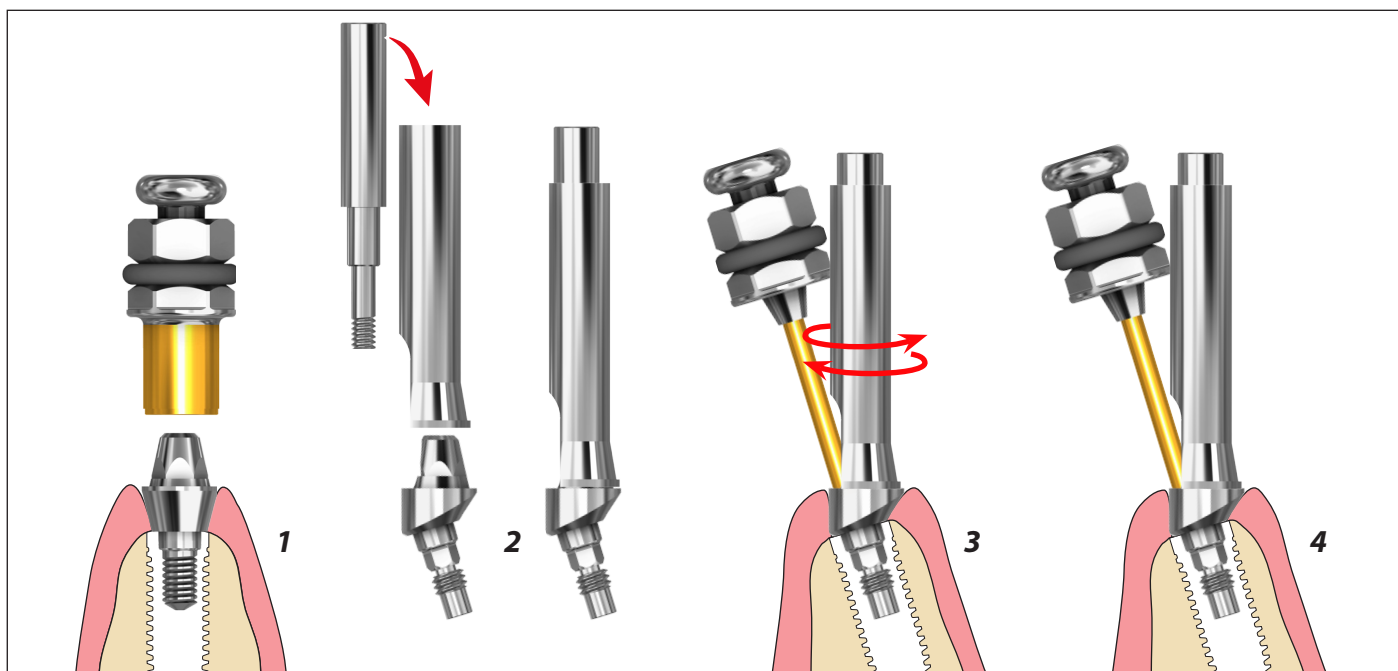

#### 4.6.2 Handling and screwing of "Easy-On-Four" abutments

**NOTE** - Given the specificity of the system for connecting the "Easy-On-Four" abutments to the implants, the screwing procedures indicated in point 4.3.2 must always be followed.

##### a) Straight abutments "Easy-On-Four"

1. Screw the abutment directly to the implant with 3.2 hexagonal driver, at a maximum torque of 32 Ncm.

##### b) Angled abutment "Easy-On-Four"

**NOTE** - For the screwing of angled "Easy-On-Four" abutments, it is advisable to have the appropriate positioning tool, which allows easier handling as well as facilitating the positioning in parallel of the emergence profile of the abutment.

2. Apply the body of the positioner to the conical emergence profile of the abutment and fix it via the supplied long screw.
3. Insert the abutment into the implant and start screwing until you feel the impact of the two hexagons, then loosen the grip of the screw (1) unscrewing by about half a turn; then slightly rotate the abutment in both directions until the hexagons are correctly taken in the optimal position provided for the correction of dysparallelism.
4. With a 1.27 mm hex screwdriver, continue screwing until an increase in torque is felt due to the friction interface of the abutment with respect to the implant seat, then complete the screwing in fully with the dynamometric instrument, applying a maximum torque of 32 Ncm until complete descent of the abutment. Remove the positioner and check complete descent with intraoral x-ray.

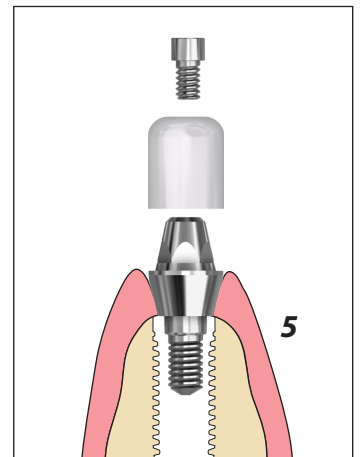

5. Protect the emergence profile of abutments with healing caps, fixing them with the appropriate screw.

#### 4.6.3 Taking the impression on the "Easy-On-Four" abutments

##### a) Analogic workflow

1. Remove the healing caps and clean the emergence profile of the abutments.
2. Apply the impression transfers, fixing them with the proper screws and apply the impression tray previously prepared for the passage of the fixing screws.
3. Fill the tray with the impression material, insert it into the mouth and exert regular pressure, gradually removing the excess material.

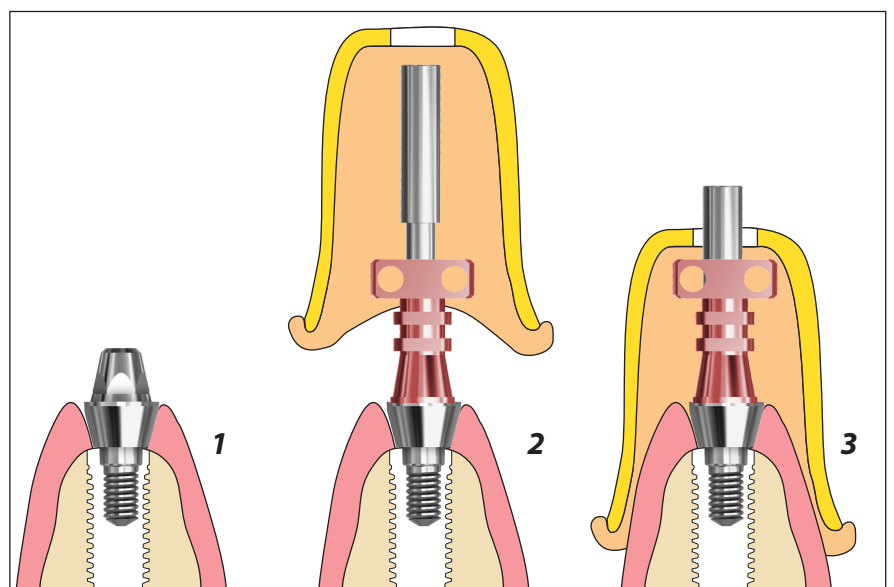

## b) Digital workflow

**NOTE** - This technique for taking the impression is feasible both with stone and stereolithographic models, obtained from a traditional or digital impression taking, in which the implant analogs have been inserted.

1. Remove the healing caps and clean the shoulder of the abutments.
2. Apply the impression scanbodies, fixing them with the appropriate fixing screws.

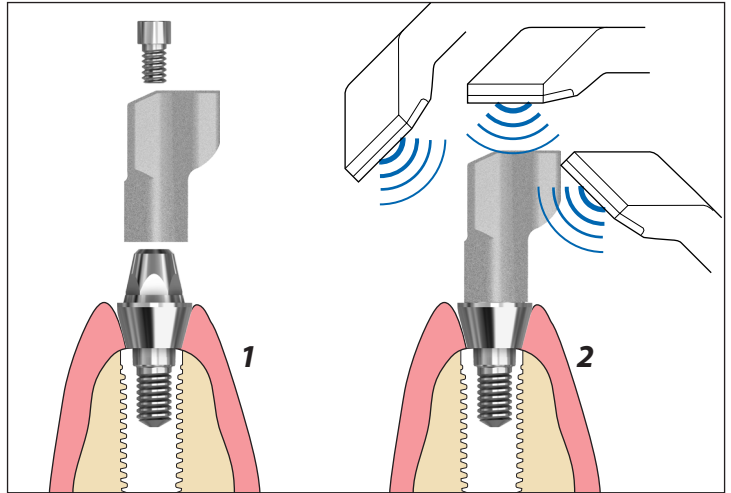

**NOTE** - The particular morphology of the scanbody has been expressly designed to ensure maximum precision in the phase of overlapping (matching) of the data; therefore it is always advisable to expose the flat surfaces in a vestibular sense, in order to facilitate the scanning of the planes by the scanner.

3. Activate the desktop scanner and scan the model, following the Manufacturer's recommendations.

### 4.6.4 CAD / CAM digital design

- In the case of a traditional impression, it is necessary to develop a model in which the specific analogs that reproduce the emergence profile of the "Easy-On-Four" abutments are placed and then perform a scan with a laboratory desktop scanner.
- Through the computerized 3D design with dedicated software, proceed with the design and modeling of the prosthetic structure.

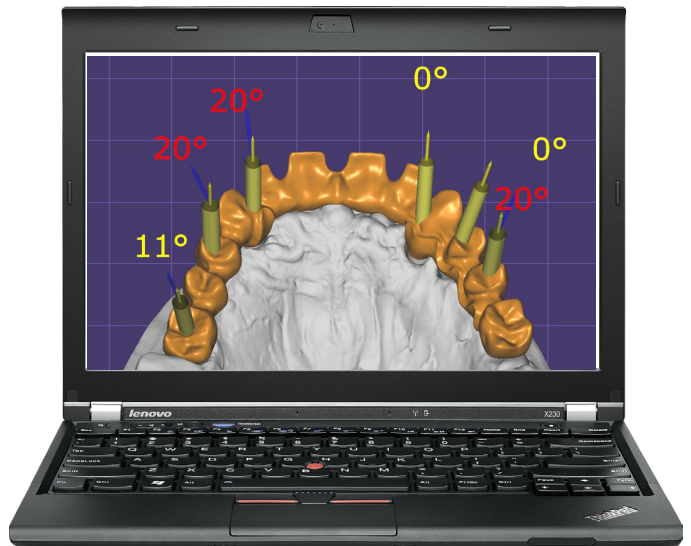

### 4.6.5 Realization of the structure with direct technique

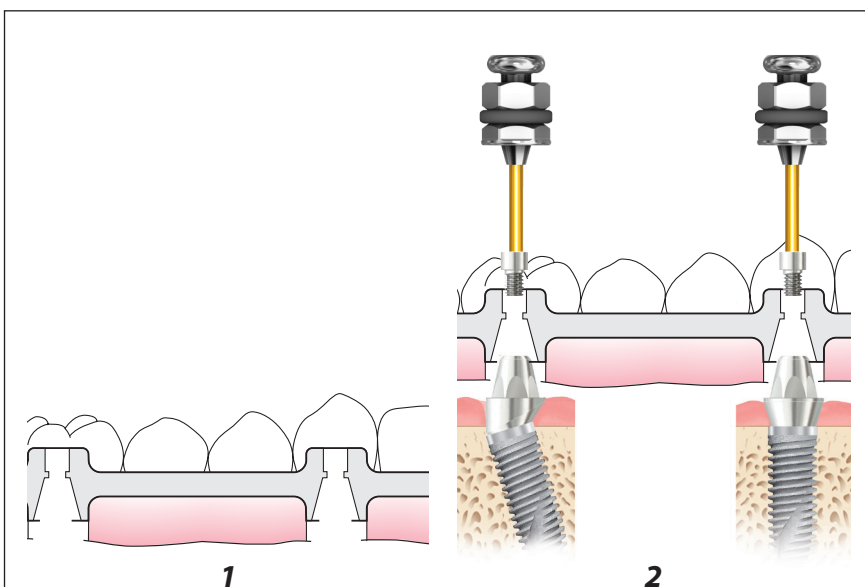

1. CAM machining of the structure with the preparation of the seats for the abutments and subsequent application of the resin flange with the assembly of the teeth.
2. With a 1.27mm hexagonal screwdriver, complete the screwing at a maximum torque of 20 Ncm.

#### 4.6.6 Construction of the structure with the bonding technique

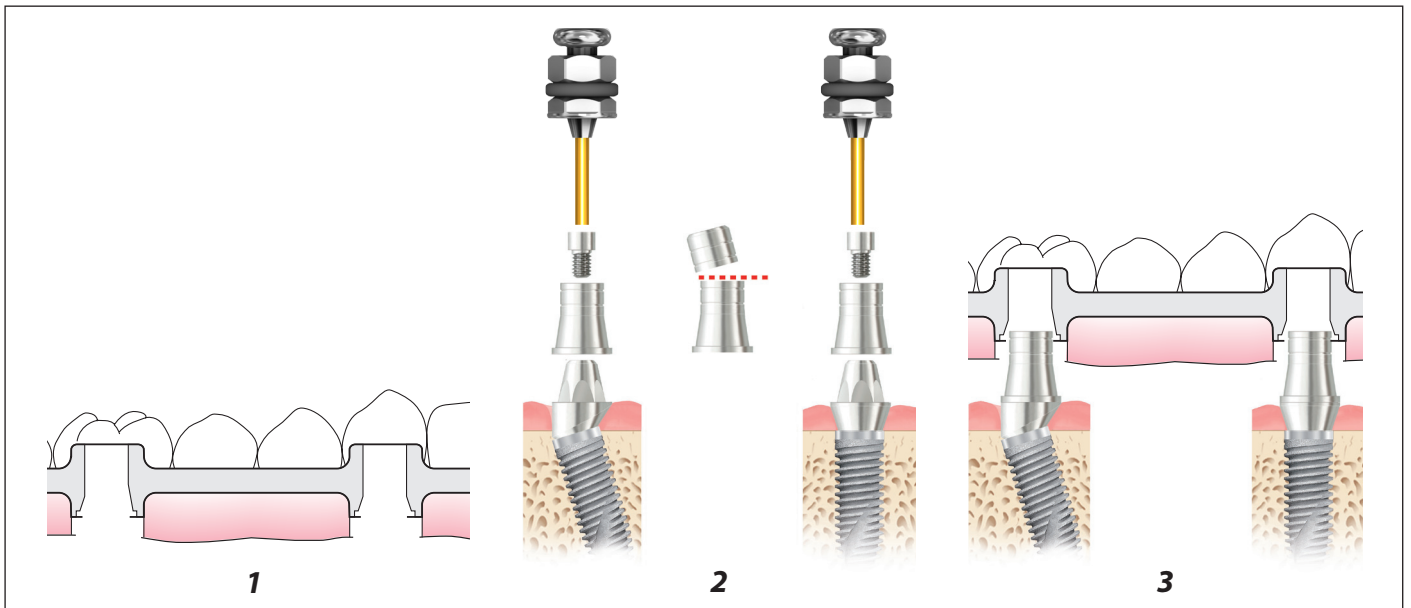

1. CAM machining of the structure with the preparation of the seats for the Titanium caps and subsequent application of the resin flange with the assembly of the teeth.
2. Adapt the height of the Titanium caps and screw them onto the Easy-On-Four abutments with a 1.27 mm hexagonal screwdriver, applying a maximum torque of 20 Ncm.
3. Fix the structure to the hoods with the gluing technique, according to the customs of the Dental Practice.

**IMPORTANT NOTE** - In no case the same fixing screws used in the laboratory for the preparation of the prosthesis should be used in the mouth.

## 4.7. Smart Digital Solutions

Smart Digital Solution is the global proposal of Bone System dedicated to Doctors and Dental Technicians for the creation of prosthetic products obtained with the support of the most sophisticated CAD / CAM design software and with the contribution of the professionalism of a highly qualified milling center, equipped of latest generation machinery, able to produce single elements or complex structures in a short time and with a high degree of precision, safety and reliability.

Through Bone System Smart Digital Solution it is possible to order:

- customized abutments,
- screwed bars and bridges
- tooth prosthesis

**Bone System Smart Digital Solution is the reliable, punctual and precise partner for Doctors and dental Technicians.**



### 4.7.1 Bone System Premium Assistance

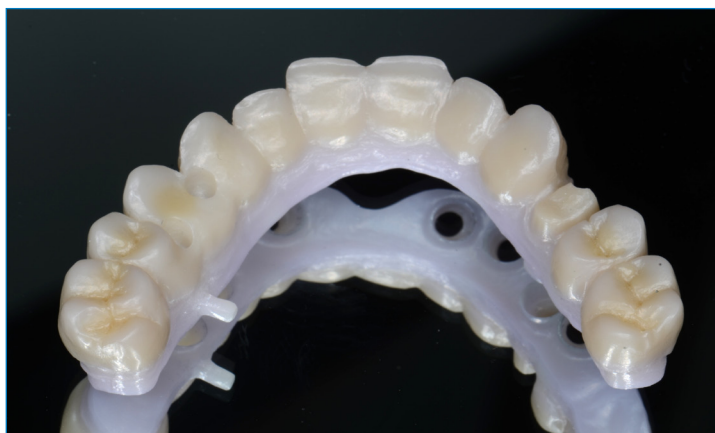

- Custom abutment design
- Components with Original Bone System "Friction Locking" connection
- Precision fit between implant and abutment
- It ensures a simplified "one-stop shop" and an efficient digital workflow

#### ● **Efficiency:**

Improvement of the productivity and efficiency of the Dental Laboratory  
50% reduction of steps compared to the traditional CAD / CAM procedure.



#### ● **Precision:**

Absolute control of fit: the Milling Center validated by Bone System ensures a perfect fit.



#### ● **Quality:**

The use of components equipped with the original "Friction Locking" connection guarantees perfect adaptation to the Bone System implants.



*Page deliberately devoid of content*



**Bone System S.r.l**

I-20134 MILANO - ITALY - Via Rubattino, 94/A - TEL. 02.21.54.165 - FAX 02.21.54.292 - e-mail: [info@bonesystem.it](mailto:info@bonesystem.it)  
[www.bonesystem.it](http://www.bonesystem.it)

CEX-EN-0422